

# Class Environmental Assessment for Minor Transmission Facilities

Pursuant to the  
Environmental  
Assessment Act

Revision 0 Mar 78  
Revision 1 Apr 79  
Revision 2 Jan 84  
Revision 3 Mar 86  
Revision 4 Dec 89  
Revision 5 Jul 91  
Revision 6 Apr 92

Report No. 89513

## PREFACE

This documents, the *Class Environmental Assessment for- Minor Transmission Facilities*, is a "parent" Class Environmental Assessment (EA) document. The purpose of a parent Class EA is to provide the basis for approval under the Environmental Assessment (EA) Act of a defined class of projects. First, the parent document is reviewed and the Class EA is approved. Then, any project subsequently proposed that falls within the defined class is automatically approved provided it is planned in accordance with the environmental planning process described in the parent document.

The Class EA for Minor Transmission Facilities was first approved under the EA Act by Order-in-Council No. 3436/80 dated December 27, 1980, subject to eight conditions. One of the eight conditions required Ontario Hydro to re-evaluate and revise the document, and to submit the revised document to the Minister of the Environment by January 1, 1984 for review under the Act. Accordingly, a revised document was submitted on December 14, 1983 and approved on March 6, 1986 by Order-in-Council No. 536/86 subject to four conditions. One of these conditions was the requirement for Ontario Hydro to again reevaluate the Class EA and advise the Minister of the results of this re-evaluation by December 31, 1989.

Ontario Hydro completed the required re-evaluation, and submitted a revised document to the Minister on December 20, 1989 for review under the Act. Further revisions were made during the ensuing review period, leading to the present version of the document (Revision 6) which was approved under the Act through Order-in-Council No. 1173/92 dated April 23, 1992. This most recent approval is subject to the four conditions presented on Page v. Condition 3 has been incorporated in Sections 3.3.2 and 3.3.3 of the main text.

The revisions leading to the present approved version of the document are based on Ontario Hydro experience with numerous projects carried out under the Class EA process since 1980 and over 20 individual EA's prepared for transmission and transmission-related undertakings, as well as valuable input from a variety of government agencies and other organizations, and consideration of other parent Class EA documents.

A number of exemption orders have been granted under the Environmental Assessment Act for transmission and related undertakings considered unlikely to have any significant adverse effects on the environment. Four generic program exemption orders are particularly noteworthy; namely OHB-2, OHC-3, OHD-4, and OHD-6. To help put the Class EA for Minor Transmission Facilities in context and to assist EA practitioners in determining whether an exemption order or the Class EA applies in future project specific circumstances, the *description of the undertaking* for each of these four program exemption orders is reproduced below for easy reference.

### **Exemption Order OHB-2**

The program of planning, designing, construction, operating and maintaining new distribution lines, switching stations and distribution stations and upgrading, expanding or rehabilitating existing distribution lines and stations that are not capable of operating at a nominal voltage of 115 kilovolts or more.

### **Exemption Order OHC-3**

The program of planning, designing, construction, operating and maintaining in order to upgrade or rehabilitate existing lines and except for emergency repairs necessary to maintain service or safety, not involving changes of rights-of-ways or the replacement of poles or towers other than changes to accommodate new road allowances or other rights-of-way. Upgrading and rehabilitating includes reconductoring, reinsulating, modifying existing poles or towers and substituting existing angle poles or angle towers.

### **Exemption Order OHD-4**

The program of planning, designing, constructing, operating and maintaining in order to upgrade, rehabilitate or expand transformer or switching stations on existing sites other than upgrading, rehabilitations or expansions which increase the facility's nominal voltage from 230 kilovolts or less to more than 230 kilovolts.

## **Exemption Order OHF-6**

The program of planning, designing, construction, operating and maintaining new transmission line taps less than 2 kilometres in route length that are capable of operating at nominal voltage of 115 kilovolts or more.

Other project specific exemption orders exist and maybe applicable in certain cases (e.g. OHJ-10 and OHK-11). OHJ-10 covers a variety of line and station projects for which Order-in-Council authorization under the Power Corporation Act had been issued as of 1976. Most of these project have since been constructed. OHK-11 covers a variety of transmission line and station projects located within the Parkway Belt West. Lists of specific projects are included in both these exemption orders. Also, Regulation 205/87 made under the EA Act may be applicable in cases where the proposed work could be categorized as a maintenance or repair activity.

**TERMS AND CONDITIONS OF APPROVAL**  
**Under the Environmental Assessment Act**  
**Order-in-Council No.1173/92 dated April 23,1992**

1. Except as provided by the subsequent conditions, the proponent shall comply with all of the provisions of the Class Environmental Assessment as accepted, which are herein incorporated by reference.
2. Ontario Hydro shall carry out a re-evaluation of the Class EA covered by this approval and advise the Minister of the Environment of the results of this evaluation by April 30, 1996. At that time, Ontario Hydro shall specify the manner in which it proposes to continue to ensure that the purposes of the Environmental Assessment Act are achieved for projects within the Class.
3. The following amendments shall be incorporated into the Class EA:
  - a) In section 3.3.2 on pages 3 - 8:

Add the following after item (e):

    - (f) Notify the Band Councils of any potentially affected Indian Reserves. Where non-Reserve Aboriginal or Metis communities may be potentially affected, notify appropriate Aboriginal and Metis organizations (e.g., the Ontario Metis and Aboriginal Association).

Delete the sentence regarding Band Councils in Item (b).
  - b) In section 3.3.3 on pages 3 - 9, revise the sentence regarding consultation to read:

"Ontario Hydro will use the screening process in consultation with directly affected government ministries, agencies, conservation authorities, municipalities, Band Councils, Aboriginal and Metis Associations such as the Ontario Metis and Aboriginal Association, special interest groups and the public in order to identify environmental concerns.
4. This approval shall terminate on April 30, 1997 or such later date as the Minister may specify, from time to time, by notice in writing to the proponent and in the Ontario Gazette.

# Contents

---

	<b>PREFACE</b> .....	iii
<b>1.0</b>	<b>INTRODUCTION</b> .....	1-1
1.1	Class Definition .....	1-1
1.2	The Undertaking .....	1-1
1.3	The Rationale for the Class EA .....	1-1
1.4	Support Documentation .....	1-2
<b>2.0</b>	<b>PURPOSE OF PROJECTS COVERED BY THE CLASS DEFINITION</b> .....	2-1
2.1	Transmission Lines .....	2-1
2.2	Transformer Stations .....	2-1
2.3	Distributing Stations .....	2-1
2.4	Telecommunication Towers .....	2-1
<b>3.0</b>	<b>CLASS ENVIRONMENTAL ASSESSMENT STUDY PROCESS</b> .....	3-1
3.1	Establish Need .....	3-1
3.1.1	Prepare a Study Load Forecast .....	3-1
3.1.2	Prepare an Inventory of Existing Supply Facilities .....	3-1
3.1.3	Carry Out Detailed Studies of Future System Conditions .....	3-3
3.1.4	Principal Considerations Determining System Adequacy .....	3-3
3.1.5	Methods of System Analysis .....	3-4
3.2	System Options .....	3-4
3.2.1	Do Nothing .....	3-4
3.2.2	Alternatives to the Undertaking .....	3-5
3.2.2.1	Transmission Facilities .....	3-5
3.2.2.2	Telecommunications Facilities .....	3-6
3.2.3	Select System Option(s) .....	3-8
3.3	Environmental Analysis .....	3-8
3.3.1	Study Area Definition .....	3-8
3.3.2	Initial Notification .....	3-8
3.3.3	Screening Process .....	3-9
3.3.4	Environmental Inventory .....	3-10
3.3.5	Identify and Evaluate Alternative Methods .....	3-10
3.3.6	Select Preferred Alternative .....	3-11
3.4	Public Involvement .....	3-11
3.5	Establish Acceptability .....	3-11
3.5.1	Final Notification .....	3-11
3.5.2	Assess Acceptability .....	3-11
3.5.3	Review and Decision by the Minister of the Environment .....	3-11
3.6	Environmental Study Report .....	3-12
3.7	Subsequent Communication with the Public .....	3-12
3.8	Monitoring .....	3-12
3.9	Addendum to an Environmental Report .....	3-12
3.10	Amending this Class Environmental Assessment Document .....	3-12
<b>4.0</b>	<b>DESCRIPTION OF PROJECTS COVERED BY THE CLASS DEFINITION</b> .....	4-1
4.1	Transmission Lines .....	4-1
4.1.1	Overhead Transmission Lines .....	4-1
4.1.2	Underground Transmission Lines .....	4-4
4.2	Transformer Stations .....	4-6
4.2.1	General .....	4-6
4.2.2	Basic Operation .....	4-6
4.2.3	Alternative Designs .....	4-7
4.2.4	Site Requirements .....	4-8
4.2.5	Station Equipment .....	4-9
4.2.6	Construction .....	4-9
4.2.7	Operation/Maintenance .....	4-9
4.3	Distributing Stations .....	4-9
4.3.1	General .....	4-9

4.3.2	Basic Design .....	4-9
4.4	Telecommunication Towers .....	4-9
4.4.1	General .....	4-9
4.4.2	Basic Design .....	4-9
4.5	Decommissioning .....	4-10
4.6	Land Surplus to Ontario Hydro Needs .....	4-10
4.7	Electric and Magnetic Fields (EMF) .....	4-10

**FIGURES**

2-1	A Typical Transmission Line .....	2-2
2-2	A Typical 230 kV Transformer Station .....	2-3
2-3	A Typical Distributing Station .....	2-4
2-4	A Typical Communication Tower .....	2-5
3-1	Class EA Study Process .....	3-2
4-1	Components of a Typical Transmission Line .....	4-1
4-2	Typical Right-of-Way Width for 230 kV 2-Circuit Transmission Line .....	4-2
4-3	Components of a Typical Transformer Station - Simple .....	4-6
4-4	Components of a Typical Transformer Station - Complex .....	4-7

**APPENDICES**

A	Ontario Hydro Regions and Areas
B	Load Forecasting Considerations and Methods
C	Accommodating the Official Load Forecast for Individual Detailed Studies
D	Inventory of Existing Supply Facilities Checklist
E	Power System Stability
F	Computer Programs Used in System Analysis
G	Environmental Inventory
H	Initial Notification Requirements
I	Subsequent Communication with the Public
J	Examples of Typical Mitigation Measures
K	Electric and Magnetic Fields

## Introduction

---

The purpose of this document is to provide the information which will enable the Ministry of the Environment to approve, following a single review, certain Ontario Hydro undertakings which will occur frequently, will be relatively small in scale, will have acceptable environmental effects, and can be planned and constructed in accordance with a common process. While ensuring the adherence by Ontario Hydro to a complete environmental study before implementing any undertaking within this class of undertakings, this approval will reduce the commitment of both Ministry and Ontario Hydro personnel to unnecessary individual reviews and approvals.

### 1.1 Class Definition

The class of projects (Class EA) covered by this document is defined to include the following:

- (a) The planning of, the acquisition of property for, and the design and construction of minor transmission lines and/or transformer stations and/or distributing stations and/or telecommunication towers, and the subsequent operation, maintenance and retirement of these facilities.

Minor transmission lines include all transmission line projects involving more than 2 km of line and which:

- (1) Are capable of operating at a nominal voltage level of 115 kV.
- (2) Are capable of operating at a nominal voltage level higher than 115 kV and less than 500 kV and which involve less than 50 km of line.

(Note: Line projects with a nominal voltage of 500 kV are excluded.)

Transformer and distributing stations include those whose station's nominal operating voltage level is not less than 115 kV and not more than 500 kV. (Where a station has more than one voltage level, the highest level is used in defining the station's nominal operating voltage.)

The line, station or telecommunication tower maybe on property or property rights previously acquired, but for a different specific use.

- (b) The planning, property acquisition, design and construction required to modify or upgrade a transmission line, and the subsequent operation, maintenance and retirement of the revised line where:
- (1) the work requires replacement of poles or towers (other than angle poles or towers) and/or changes in the right-of-way for existing transmission lines capable of operating at a nominal voltage of 115kV or higher and not more than 500 kV; and,

- (2) the upgraded existing lines would operate at a nominal voltage of 115 kV or higher and not greater than 500 kV.

- (c) The planning, property acquisition, design and construction required to modify or expand a transformer station, and the subsequent operation, maintenance and retirement of the revised station where:

- (1) An extension of the site is necessary; and,
- (2) the revised station is capable of operating at a nominal voltage level of not less than 115 kV and not more than 500 kV. (Where a station has more than one voltage level, the highest level is used in defining the station's nominal operating voltage.)

(Note: Both overhead and underground transmission line projects are covered by this document.)

### 1.2 The Undertaking

The undertaking for which approval is hereby requested is any project which falls within the class of projects defined above and which has been identified and deemed environmentally acceptable by the process described in this document.

### 1.3 The Rationale for the Class EA

The Class EA approach has proven to be an effective way of meeting the requirements of the Environmental Assessment Act.

The past nine years have shown that the projects within the class occur frequently, are small in scale, have a predictable range of effects and are able to utilize the same planning process.

Other alternatives shown below were examined to determine if they would better meet the requirements of the EA Act:

- (a) Individual EA's;
- (b) An exemption for the class of projects covered by the Class EA;
- (c) Individual exemptions;
- (d) A suitable combination of the foregoing.

Ontario Hydro's experience with individual EA's, exemption orders and the Class EA process has shown the Class EA process to be an effective way of ensuring that minor projects are planned and carried out in a manner which is environmentally acceptable. The process has proven to be economical with respect to both time and money when compared with individual environmental assessments. It was concluded also, that in addition to being an effective way of

meeting the requirements of good planning, it also provided the best way of meeting the intent of the Environmental Assessment Act. This conclusion was confirmed by government ministries during the previous two reviews of the Class EA. Members of the public have not specifically commented on the Class EA process, however, the project work undertaken to date has indicated that the process has been satisfactory.

Should an objection be raised on a future project, either by a government reviewer or a member of the public, the process ensures that the rights of the objector are protected. The Class EA process requires that any objection, filed during final notification, either be resolved or forwarded to the Minister of the Environment for a decision on the suitability of the process in dealing with that project. In some instances, Ontario Hydro may decide to proceed with an individual EA even though the physical parameters are suitable for the Class EA process.

#### **1.4 Support Documentation**

Reference is made in this document to the following:

#### ***Environmental Guidelines for the Construction and Maintenance of Transmission Facilities.***

This document has a three-fold purpose:

- (a) to be used by design, construction and maintenance personnel of Ontario Hydro to minimize environmental changes;
- (b) to assist those involved in reviewing environmental assessments; and,
- (c) to provide information to the general public and to those specifically affected by transmission facilities.

#### ***Protocol for Community Noise Control.***

This document sets out the design philosophy and criteria applied to limit audible noise during construction and operation of Ontario Hydro facilities.

#### ***Property and Compensation Policies.***

This document describes the policies and procedures involved in the acquisition of property rights for high voltage transmission line rights-of-way and station sites.



## Purpose of Projects Covered by the Class Definition

---

### 2.1 Transmission Lines (Figure 2-1)

Any project within the class consisting, entirely or in part, of a new or upgraded transmission line, would have one or more of the following purposes:

- (a) To transmit electrical energy to an existing or proposed Ontario Hydro owned or customer-owned transformer or distributing station.
- (b) To connect parts of the Ontario Hydro system, or to interconnect with neighbouring utilities or non-utility generation facilities to improve the system's capability and/or reliability.
- (c) To strengthen existing connections between parts of the Ontario Hydro system.

### 2.2 Transformer Stations (Figure 2-2)

Any project within the class consisting, entirely or in part, of a new or extended transformer station, would have one or more of the following purposes:

- (a) To transform electrical energy from a transmission voltage (115 kV or above) to a subtransmission or distribution voltage (less than 115 kV), for distribution by a municipal utility or directly by Ontario Hydro to low-voltage customers. Where the transformation is small, a station having this purpose only may be referred to as a distributing station.

- (b) To transform electrical energy from one transmission voltage to a lower transmission voltage, or vice versa, to interconnect parts of the Ontario Hydro system to improve the system's capability and/or reliability.

- (c) To connect together, or bus, sections of the Ontario Hydro system through automatic switching devices, to improve the system's capability and/or reliability.

### 2.3 Distributing Stations (Figure 2-3)

Any project within the class consisting, entirely or in part, of a new distributing station which would serve the purpose of transforming electrical energy from a transmission voltage to a distribution voltage for distribution to Ontario Hydro's rural distribution electricity system.

### 2.4 Telecommunication Towers (Figure 2-4)

Any project within the class consisting, entirely or in part, of a telecommunication tower, would have the purpose of providing a suitable structure for supporting telecommunication antennas. Telecommunication antennas are used by Ontario Hydro for transmitting, receiving or repeating radio signals. The radio signals are used primarily for the protection and control of the electric power grid and the facilities connected to it, as well as for maintenance communications.

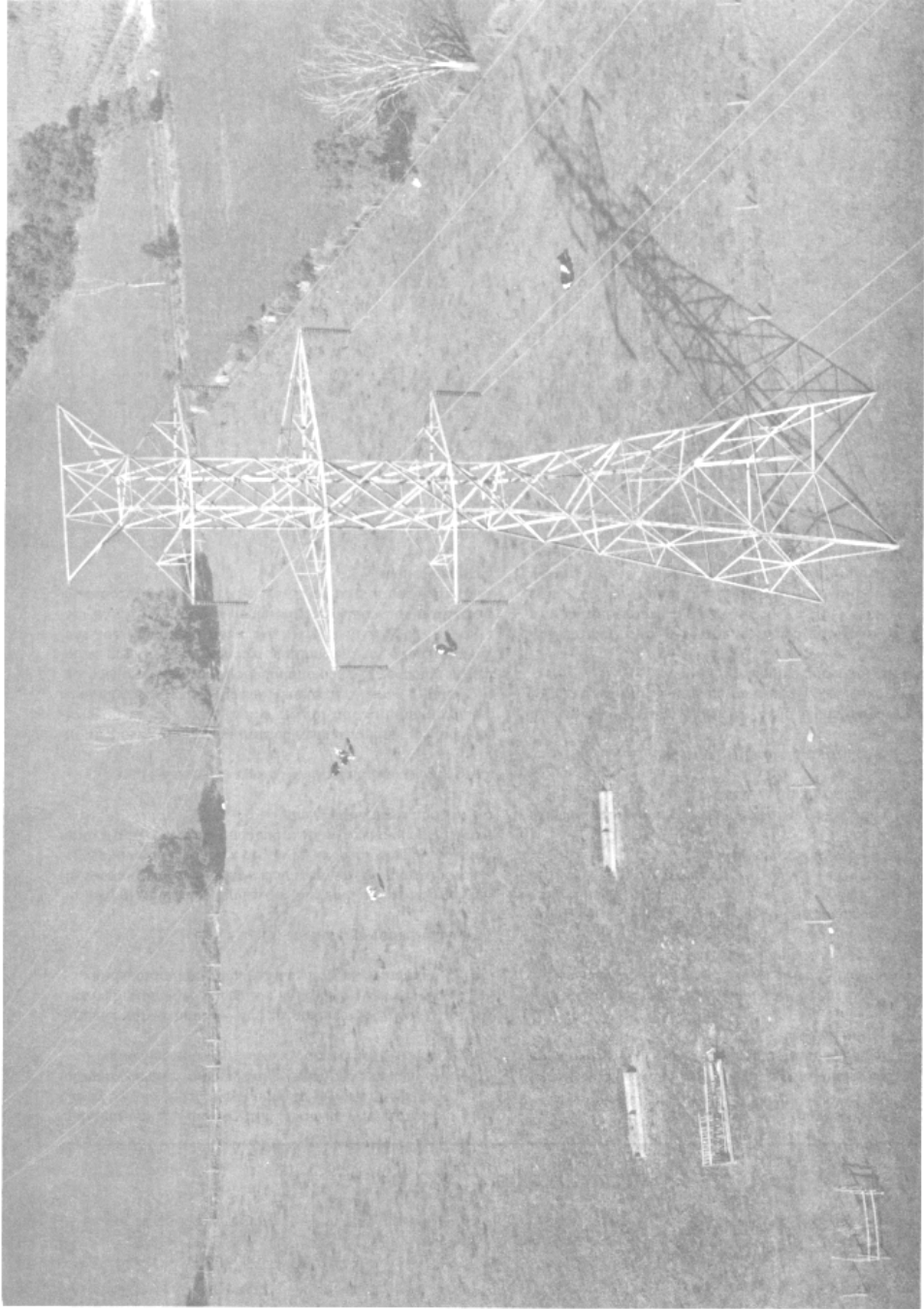

**Figure 2-1**  
**A Typical Transmission Line Application**

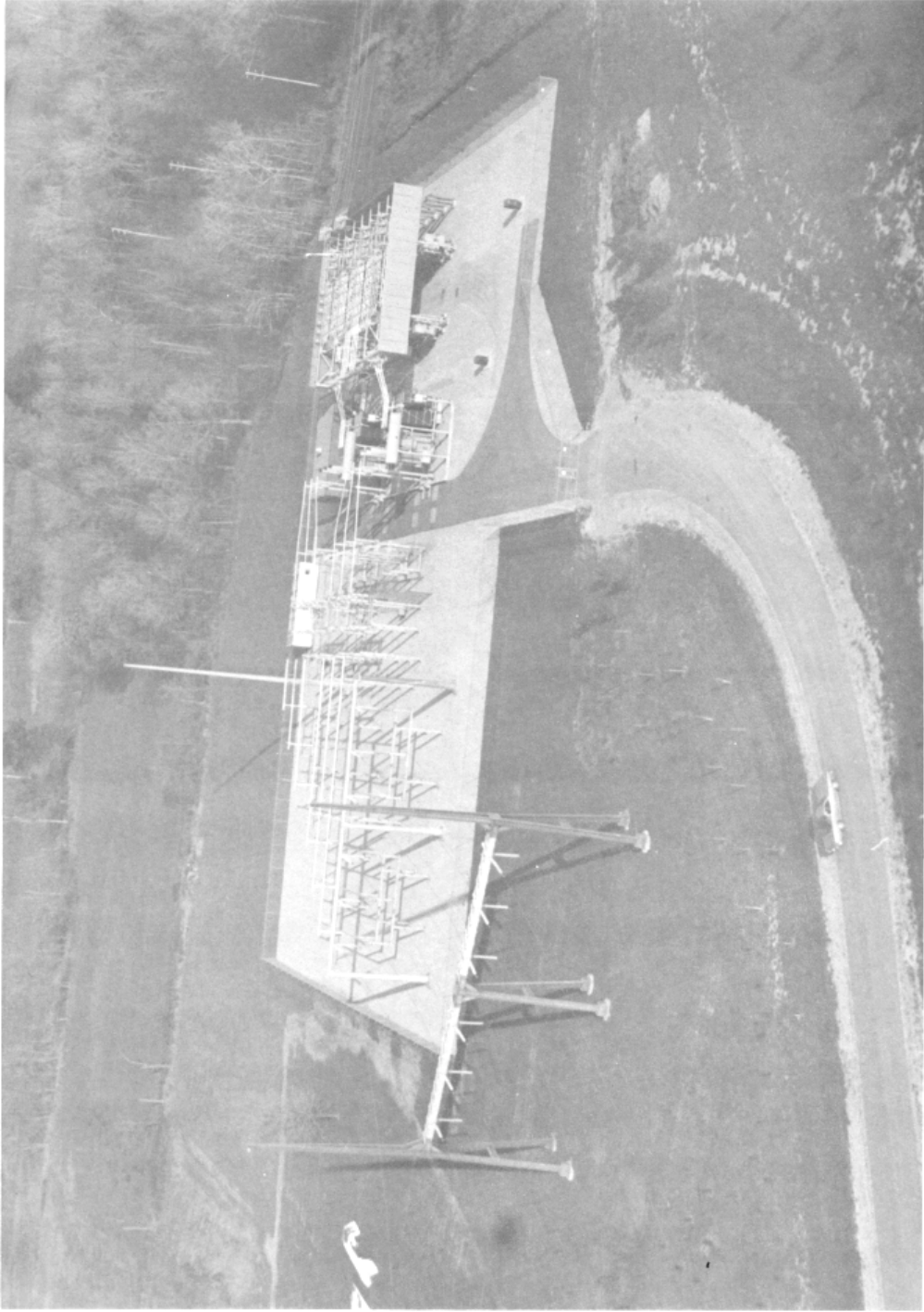

**Figure 2-2**  
**A Typical 230 kV Transformer Station**

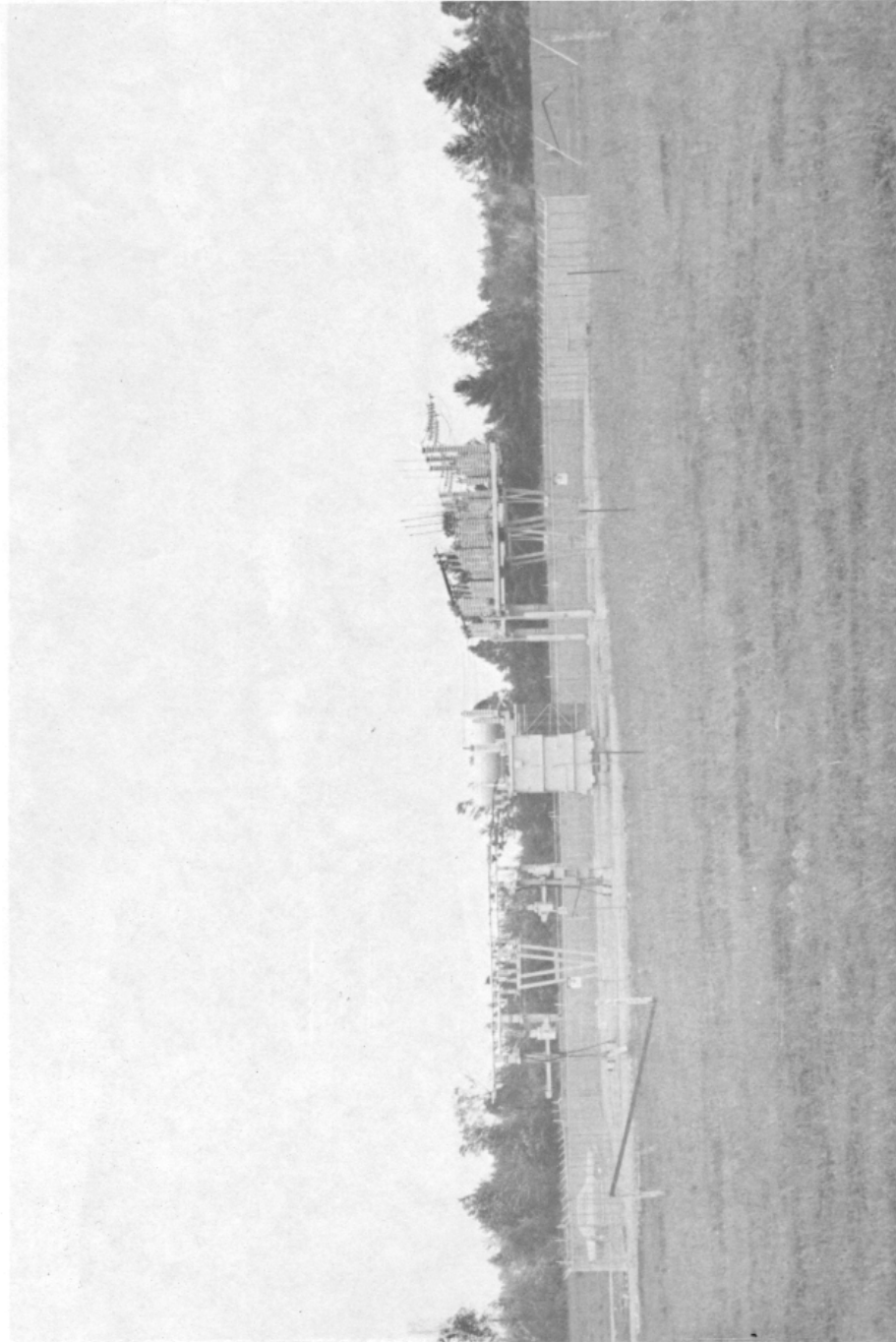

**Figure 2-3**  
**A Typical Distributing Station**

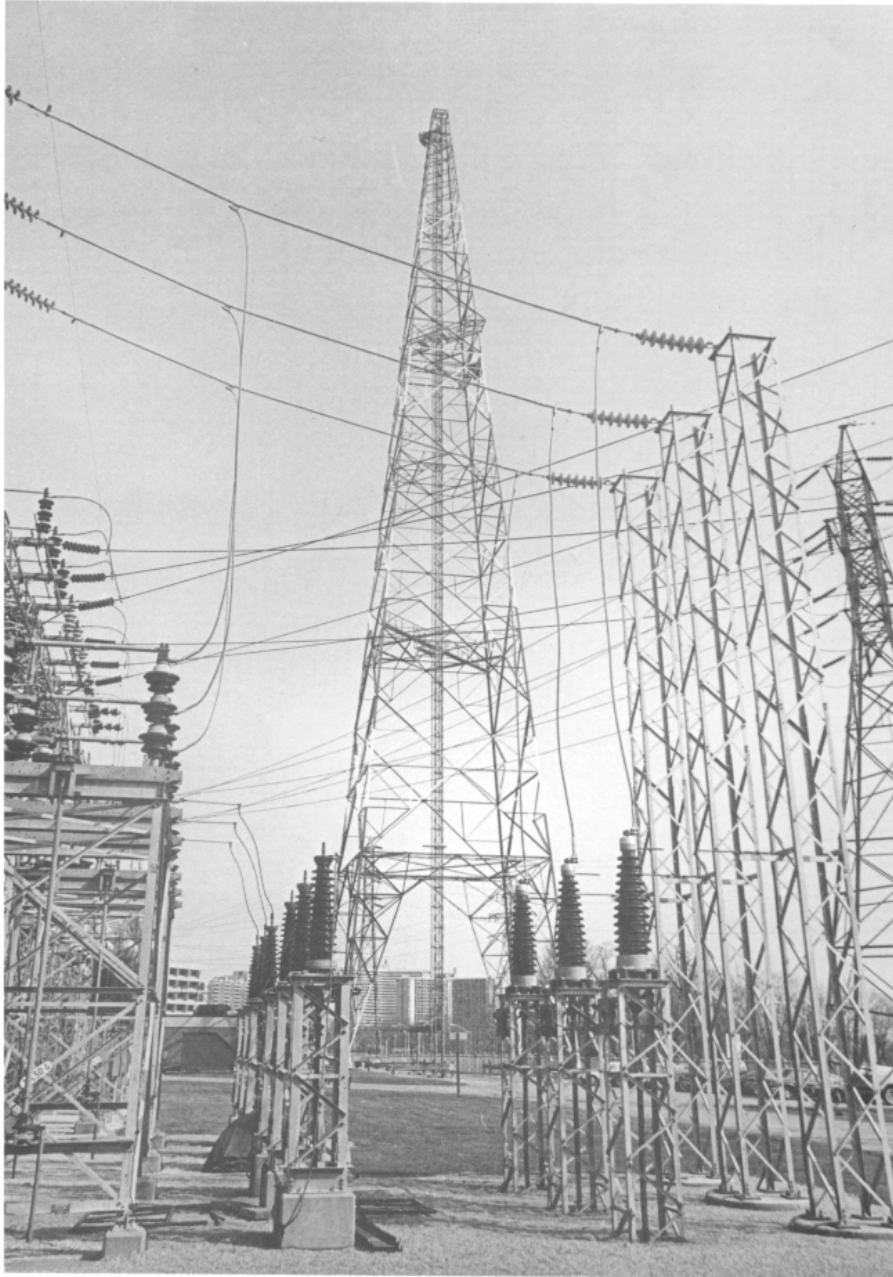

**Figure 2-4**  
**A Typical Communication Tower**

### 3

## Class Environmental Assessment Study Process

---

The study process which Ontario Hydro proposes to follow to establish whether or not any specific project can be considered environmentally acceptable is illustrated in Figure 3-1 and is described in detail in this chapter.

### 3.1 Establish Need

It is the responsibility of Ontario Hydro to be continually aware of the extent to which recent past loads have taxed, and the extent to which anticipated future loads will further tax, the capabilities of the various transmission line and transformer station components which make up the Ontario Hydro system. This awareness comes primarily from routine planning reviews. These routine reviews are sufficient to indicate weak spots or areas of concern in the system. More detailed study must then be carried out to establish why, where and when the system will become inadequate and to determine the consequences of the inadequacy.

In addition, specific information may become available from internal or, more usually, from external sources which will precipitate a detailed study of the adequacy of existing facilities in a particular area. Examples of such information are:

- (a) A new industry is proposed for a specific location.
- (b) A significant commercial and/or residential development is announced.
- (c) The actual capability of an existing facility is found to be less than anticipated.
- (d) A non-utility generator wishes to supply electricity to Ontario Hydro.

The necessary detailed studies are then carried out in three states:

- (a) Detailed data concerning the anticipated future requirements are prepared, e.g., load forecast.
- (b) Detailed data concerning the capabilities and limitations of the existing facilities are assembled.
- (c) Future conditions are studied using these data to establish when the existing facilities will become inadequate and what the consequences of the inadequacy may be.

#### 3.1.1 Prepare a Study Load Forecast

Load forecast reports are prepared annually by Ontario Hydro. Each report includes details of the expected or most likely peak demands monthly for the current year and following year and for December only for the succeeding four years for each of Ontario Hydro's wholesale customers. Included as wholesale customers at present are about 316 municipal utilities, five Ontario Hydro regions divided into a total of 47 areas (see Appendix A) and 106 large (over 5000 kW)

direct industrial customers. Appendix B, Load Forecasting Considerations and Methods, gives an explanation of why electrical load grows and how Ontario Hydro attempts to forecast this growth.

These load forecast reports constitute the starting point for most of the planning activity within Ontario Hydro. While designed to provide a consistent basis for this planning. Sometimes the forecast data cannot be used directly in the form presented in the report. For example:

- (a) If the forecast data are for a large utility or area, they must usually be broken down into smaller components representing, for example, that portion to be supplied by a single transformer or distributing station, or part of a single transformer or distributing station, or that portion lying within defined geographic sections of the municipality or area.
- (b) If the detailed planning study contemplated includes all or parts of two or more municipalities and/or areas, the forecasts and forecast components for those customers must be combined into one (or several) comprehensive forecast(s).
- (c) In many cases the study must extend beyond the time period of the load forecast report. In these cases, the official forecast must be projected further into the future.
- (d) The forecast is given in kilowatts, the measure of the real power requirement of customer load. This must be converted to apparent power (kVA) for the study, where apparent power is the product of the current and the voltage required by the load and includes the real power component and a reactive power component.

The methods used in carrying out these four steps are described in Appendix C.

As previously mentioned, the load forecast report indicates the most likely future load requirements. The usual practice in planning studies is to investigate the effects of other rates of load growth so as to establish whether or not and to what degree the need for new facilities and the nature of those facilities is sensitive to load growth.

#### 3.1.2 Prepare an Inventory of Existing Supply Facilities

For purposes of preparing an inventory of existing supply facilities, it is convenient to deal with the facilities under the following categories, opposite their function.

- (a) *Generation:* The total Ontario Hydro dependable peak resources in the winter of 1988/89 were about 28,000 MW. These resources included about 6,500 MW (23 per cent) in hydraulic generating stations, 11,000 MW (39 per cent) in fossil-steam (or conventional thermal) generating, stations, and

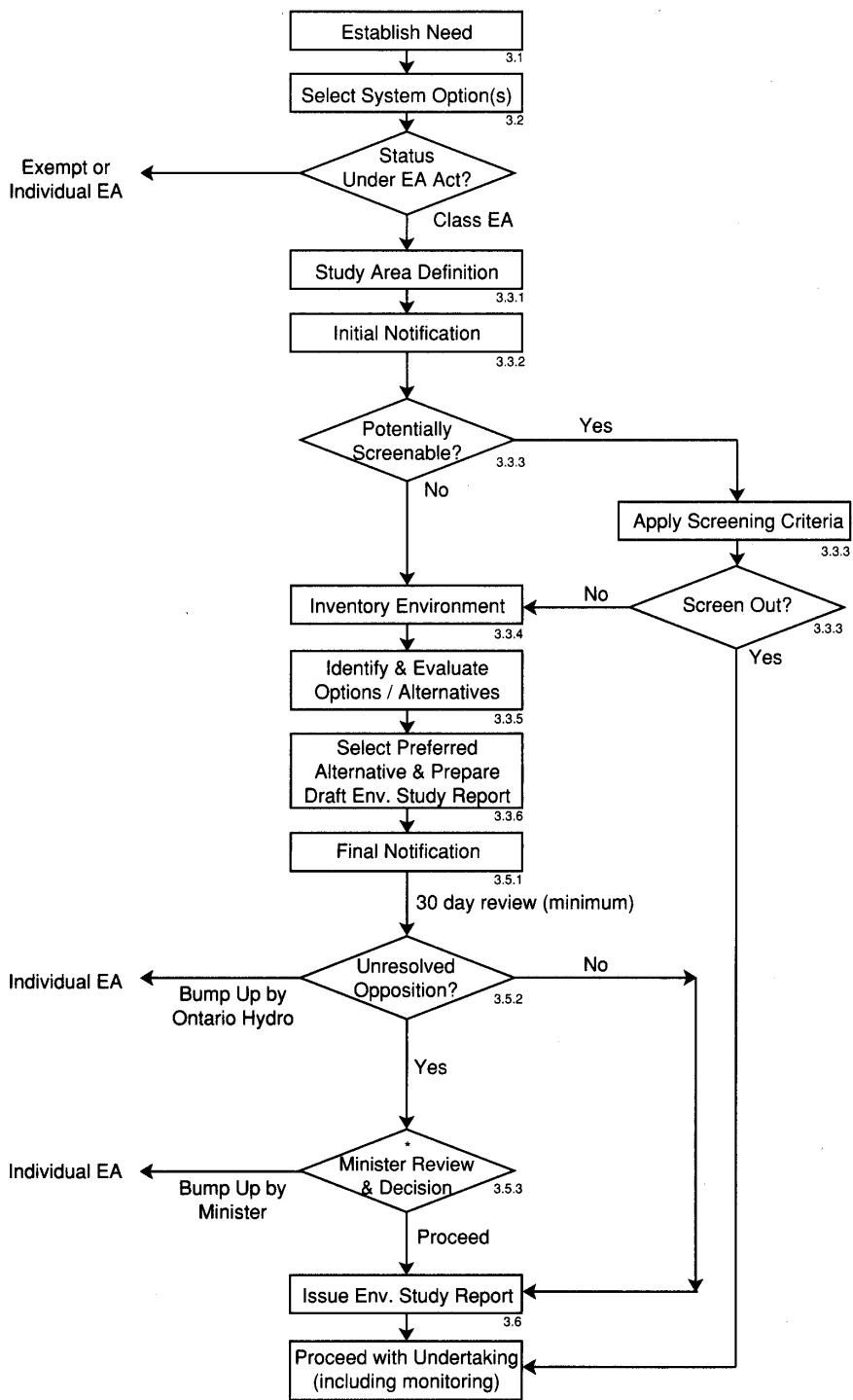

FIGURE 3-1  
Class Environmental Assessment Study Process

\*Note - Refers to  
Minister of the Environment

10,500 MW (38 per cent) innuclear generating stations. A further 2,100 MW of generation resources were mothballed or frozen.

- (b) *Bulk Transmission System:* The bulk transmission system (grid) is comprised of a network of lines operating at 500 kV, 230 kV and 115 kV which interconnect major generating stations, (b) major transformer stations, and the interconnections with neighbouring utilities.
- (c) *Regional Supply System:* The regional supply system is comprised of the Ontario Hydro and customer-owned transformer stations and any 230 kV and 115 kV lines connecting these stations to the grid. It is expected that a majority of the undertakings covered under this document will consist of supply facilities within the regional supply category.
- (d) *Subtransmission/distribution:* The subtransmission/distribution system consists of 44 kV, 27.6 kV and 13.8 kV overhead and underground lines connecting transformer stations to Ontario Hydro or customer-owned distributing stations or providing supply to single phase customers. The function of these lines is to transmit the power from the transformer station to (c) distributing stations and to some individual customers.

The preparation of the inventory involves a detailed examination of the system components within each category. A checklist for carrying out this work is provided in Appendix D. Only pertinent items in the inventory are dealt with in a particular study.

### 3.1.3 Carry Out Detailed Studies of Future System Condition

Once the load forecasts and the inventory of existing facilities relating to any area of concern are prepared, system analyses will be carried out to establish the adequacy of those facilities to supply those future loads.

### 3.1.4 Principal Considerations Determining System Adequacy

There are six principal factors which must be considered in the assessment of an electric power supply system's technical adequacy:

- (a) *Thermal Limits:* Each piece of electrical equipment has the capability to carry a specific maximum electric current continuously and, in most cases, larger currents for shorter periods of time (the shorter the period, the larger the current). If the equipment is required to carry more current than it is capable of carrying, damage will result. Depending on the magnitude of the overcurrent, this damage may simply reduce the life of the equipment or it may cause immediate failure. In the case of a transmission line, the overload must be limited to prevent the conductor from sagging to the extent that the clearance to ground or objects below the line becomes unsafe. This limit depends on the ambient temperature and wind conditions

of one or more of the elements that comprise

An inadequacy which causes a slight reduction in the life expectancy of a piece of equipment could be considered acceptable under certain conditions. As an example, it would likely be acceptable to reduce the life of equipment that will have no further use when it is removed, provided the risk of failure is very low.

- (b) *Voltage Limits:* Every piece of electrical equipment is designed to operate within a specific voltage range. The effects of being forced to operate at voltages outside this range will depend on the type of equipment. An overvoltage applied to a resistive device (incandescent lamp, heater, etc.) could result in an overcurrent and shortened life or even thermal failure; applied to other electric equipment (motor, transformer, transmission line), it may cause insulation failure. An undervoltage could cause a motor to overheat or fail to start and a resistive device to be less effective, i.e., to produce less light (or heat) output. In particular circumstances, if the departure from the normal voltage range is not excessive or occurs infrequently, the consequences might be considered acceptable. Low voltages reduce the capability of the bulk electrical system to transmit power.

- (c) *Reliability:* Reliability is defined in general terms as the degree of continuity of full electric power supply delivered to the user's premises. Perfect reliability would mean that full electric supply is available 100 percent of the time. There are six factors which affect the customer's perception of the impact of a power interruption:

1. Frequency with which it occurs
2. Duration
3. Amount of advance warning
4. Size of area affected or number of customers involved
5. Time of day or year
6. Cause

- (1) The first is *availability*, which is the probability that an individual element of the system (generator, transmission circuit, transformer, etc.) will be operable, i.e., not out-of-service due to a fault, equipment failure, incorrect operation or maintenance. Availability includes a consideration of the duration of each period of availability (or more usually of its converse, the duration of each period of unavailability) and the frequency of occurrence.

- (2) The second aspect of power system reliability is security. Security covers the ability of the system to withstand the sudden shock of the loss

- (f) *Losses:* In any electric equipment or transmission line



the system.

Three levels of security can be considered for a supply to a transformer station, namely:

- Where the loss of one element only (a transmission circuit, a transformer, a generator, etc.) will result in the loss of load.
- Where the loss of one element only will not result in the loss of load.
- Where the loss of a second element with one already out of service will not result in the loss of load.

Which level is to be applied in any situation is somewhat judgmental and takes into account the size of the load and the expected performance.

*Availability* is evaluated using probability mathematics.

*Security*, because of its complexity, is evaluated by trial using a computer model of the system. The borderline between adequate and inadequate reliability is less than absolute. Ontario Hydro relies on guidelines established internally and in co-operation with the other interconnected utilities in the Northeastern United States for assessing the generation and bulk power system reliability.

More information on reliability is available in several Ontario Hydro publications including the submission on Reliability to the Royal Commission on Electric Power Planning (RCEPP) with respect to the Public Information Hearings, dated May, 1976.

- (d) *Stability*: Stability denotes the ability of the generators supplying a power system to remain in Synchronism or to hold together through normal system, and is therefore described in some detail in Appendix E.
- (e) *Protective Co-ordination*: Most components of an electrical supply system are protected from damage by automatic devices which isolate the component quickly from the system in the event of abnormal conditions such as a shortcircuit. These devices must be able to differentiate between what is a normal situation and what is an abnormal and potentially dangerous one. For instance, a device monitoring the current in a line must be able to differentiate between current swings due to normal load changes and those higher currents caused by a short circuit somewhere long the line.
- It is necessary to leave a margin between the maximum normal current which will not cause the device to operate and the minimum abnormal current for which it must operate. The consequences of reducing this margin are sometimes acceptable.

through which a current flows, there are electrical losses. Since the system generation must supply these losses as well as the load, the losses can be assigned a dollar value. This value is included in the economic analysis of system options. The additional generation required to make up for these losses may have environmental implications.

### 3.1.5 Methods of System Analysis

Computer programs are used to model the behaviour of the power system at some future point in time. The effect of various natural events or equipment failures can be simulated. Some of the major programs used in system analysis are: load flow, transient stability, small-signal dynamic stability, short-circuit and transformer aging.

These programs are described in Appendix F.

### 3.2 System Options

Usually the same computer programs and planning expertise used to determine the inadequacy will be employed to identify technically feasible methods by which the inadequacy could be overcome or deferred. These methods might include work by Ontario Hydro, a municipal utility, a direct customer, a nonutility generator or some combination of these. While it is necessary that all of these options must satisfy the short-term problem, i.e., the inadequacy. They may or may not have the same long-range technical benefits. That is, one option may be good for three years before further inadequacies occur, another may be good for ten years, while a third may be good for three years but result in different inadequacies at the end of that time than would the first option.

It is essential, therefore, that the development of the options to overcome the short-term inadequacy be carried out sufficiently far into the future so that additional stages of each can also be considered. The time period covered by the study must be from the date of the initial inadequacy, either to that future date when all options arrive at the same end result or to that future date when even major differences become insignificant in terms of the present worth of their costs.

Having established the technical options, rough comparative estimates will be prepared of the cost of all facilities for all stages of each option. Using this cost data and suitable escalation and discount rate data, a gross economic comparison of the options will be made and any options which are obviously uneconomical will be discarded. Care will be taken in making any decision to discard an option at this time because relative environmental impacts will usually not yet have been fully considered. If the economics are not obvious and unequivocal, the option will not be discarded. Justification for discarding any option will be included in the study documentation.

#### 3.2.1 Do Nothing

A decision would then be made as to the acceptability of the consequences of living with the inadequacy based on a comparative evaluation of the cost of alternative remedial

measures against the cost of the consequences. It must be realized that this latter cost cannot usually be expressed in dollars. If the consequences are considered acceptable, the remedial work can be deferred. If the deferment is long enough that no further study is required at that time, the situation would be documented and scheduled for review at a subsequent date. If the consequences of the inadequacy are considered unacceptable, then the need to overcome (or defer) the inadequacy has been established.

Environmental considerations are one of the factors which are considered in treating the do nothing alternative.

In the normal circumstances, this decision is made solely by Ontario Hydro, possibly with input from particularly affected wholesale customers. In certain instances, a customer may desire a supply which is more secure than that which would normally be provided to him. In such cases the customer would be required to pay the extra cost and the need for the extra facilities would be documented. If conditions change during the course of the study, this option will be re-evaluated. The Environmental Study Report will also address the option.

### **3.2.2 Alternatives to the Undertaking**

The undertaking includes those transmission and communications facilities as defined in Section 1.1, for the purpose outlined in Chapter 2 and described in Chapter 4.

For the purpose of examining "Alternatives To", the undertaking will be divided into Transmission Facilities and Telecommunications Facilities.

The following alternatives are examples of those Ontario Hydro normally considers. Others may be evaluated on a case-by-case basis as appropriate. This evaluation will include the net effects of both the alternatives to the undertaking and the alternative methods of carrying it out on the natural and social environment, including such environmental concerns as streambank erosion, visual effects, soil compaction, etc.

*The Environmental Guidelines for The Construction and Maintenance of Transmission Facilities* contains a general range of mitigative measures. The appropriate mitigation for a specific situation will be determined on a case by case basis because of the importance of existing physical characteristics.

#### **3.2.2.1 Transmission Facilities**

##### **Alternative Energy Technologies**

The alternatives include solar energy, wind power and the use of wood or municipal solid waste to fuel boilers. These alternatives affect the environment in various ways. A brief description of the various alternative technologies follows:

##### **Solar Energy**

Two methods of using direct solar energy are currently undergoing research and development in many countries, particularly in the United States. One method involves direct

conversion of solar energy to electricity using photovoltaic cells. The other employs a direct thermal process where solar energy contributes directly to space heating of the house. This is known as "passive solar" heating.

The photovoltaic cell or solar cell is capable of generating electricity directly from sunlight. Currently, the cost of such a system is comparatively high and, in most cases, would not be a viable alternative.

Aside from the high cost, photovoltaic panels require roof tops or vacant land to contribute to electricity supply. It is estimated that an average of only 0.3 KW h m<sup>2</sup>/day could be generated by photovoltaic cells. While photovoltaic technology is not seen as a significant bulk system supply option, it may be used in remote communities to reduce diesel fuel consumption.

Ontario Hydro currently operates a photovoltaic -powered environmental monitoring station at Atikokan as part of an awareness program and in recognition that there are special applications for which such devices may be suitable. Also, a 10 kW photovoltaic installation has been in operation since 1986 at the remote community of Big Trout Lake. This installation operates as a fuel savings device in combination with diesel generation facilities.

The most promising future application of solar energy in Ontario may lie in "passive solar" space heating, which does not directly produce electric power. Depending on windows facing south and on house design, generally between 25 and 50 per cent of a home's total heating requirements could be met by solar energy. This being a specific design feature it cannot be broadly applied. In addition, most heating requirements occur in winter when the daylight hours are short (seven hours) and the sun is at a low angle, therefore, supplementary heating systems are still required. The capital cost required for two systems is significant and, as a result, the possibility of implementation is small. Because of these factors, solar heating systems will not have much effect on Ontario Hydro's capacity requirements, but will still be considered on an individual basis.

##### **Wind Power**

In the past, many countries throughout the world have used windmills to pump water, grind grain and supply electricity for remote regions. In theory, the concept of wind power is simple; the wind turns the blades of a windmill, which drives a generator to produce electricity. The technology of harnessing wind power exists, and some individuals are using wind power on a small scale to supply their personal energy needs.

The low average wind speed in Ontario results in the need for large areas of land for windmills, and poses serious environmental and economical obstacles in using wind power economically on a large scale, especially in urban areas. To contribute to the generation of electrical energy, the windmill should be exposed to steady wind speeds averaging over 9 m/s. A wind turbine generator (WTG) does not supply energy on demand unless the energy generated is stored and that is expensive. The unpredictable and variable output of WTGs makes it necessary to provide a back up system to meet the

demand during the period of calm and low winds. These economic, technical and land use problems, in addition to undesirable environmental effects such as noise and interference with TV signals, hinder the application of wind power for energy supply in Ontario. The mitigative measures are dealt with on a specific case by case basis since effects such as noise, TV interference, etc., are highly dependent upon the existing physical environment.

In cooperation with the Federal and Provincial governments, the Canadian Electrical Association and Howden (a turbine manufacturer), Ontario Hydro has contributed to a 60 kW wind turbine generator demonstration project at the remote community of Fort Severn. However, wind generation is not foreseen as a bulk system supply option for Ontario. Limited use of wind turbines as diesel fuel saving devices in remote communities does offer some potential. Backup facilities will be required for times when the wind is not blowing.

### ***Burning Wood or Municipal Solid Waste***

For economic reasons, the generation of electricity from both wood and municipal wastes tends to take place near the source of fuel. Wood fired generation is achieved in relatively remote locations. Energy from Waste facilities is located in or near urban areas.

The electricity generated from these facilities may assist in the solution of localized supply problems. The typical availability of electricity from an Energy from Waste plant is in the range of 80 per cent. During shutdown periods, the use of a transmission facility may still be required. This will depend on the area's dependence on this source of power and the availability of redundant equipment at the plant.

Also to be considered are the environmental implications from the burning of municipal waste or wood. The siting of waste disposal facilities, including Energy from Waste plants, often cause concern to the citizens living in the immediate area. However, mitigation measures and a public review process are available to deal with any potential impacts to the environment.

Although economics usually preclude Energy from Waste as an alternative to a minor transmission, it should be considered when there is a local power supply problem. Ontario Hydro recognizes the potential societal benefits of an Energy from Waste facility in the overall context of municipal solid waste disposal programs. Therefore, if relevant municipal governments have specific plans to establish an Energy from Waste facility, then Ontario Hydro will give due consideration to such a facility as a solution to any identified electrical power distribution problem.

Similarly a specific plan to generate electricity using wood will also be given due consideration, as an alternative solution to a power distribution problem. Wood-fuelled generation is not expected to play a significant role in meeting Ontario's electricity needs, except as a fuel in cogeneration stations.

The forest products industry in North America uses large

quantities of wood wastes or wood by-products as fuel to generate heat and electricity. Utility-owned wood-fired stations are less common. Two large 50 MW facilities exist in the States of Vermont and Washington, large facilities are necessary for economic generation. However, large facilities require more fuel than can usually be economically supplied. Wood would have to be collected from distant regions, resulting in an increase in transportation and collection costs, and potentially significant impacts to transportation routes. Alternatively, tree farms would have to be developed for the specific purpose of providing fuel for the facilities. Tree harvesting has to be carefully coordinated with reforestation programs. The adverse environmental impacts of mass harvesting include jeopardizing wildlife and its habitat, soil stability, water control and local climate.

Although the supply of wood fuel in Ontario is enormous, about 30 million oven dry tonnes a year, only about one million tonnes could be made available for generating electricity. Much of the fuel potential has already been allocated to other users or is unavailable because of technical or environmental considerations. In the future, it is estimated that the available fuel could generate between 50 and 70 MW of electricity. The most attractive opportunities for using this fuel source are expected to be associated with cogeneration.

Ontario Hydro recently participated in the development of a 7 MW wood-fuelled cogenerating station by purchasing the power from a Chappleau cogenerating station, which went into service in 1986. A similar venture is being considered for Brockville. Further economic development could result in 50 MW of wood-fuelled electricity generated within the Province by 2004.

### **3.2.2.2 Telecommunications Facilities**

#### ***Radio Telecommunications***

Radio telecommunications in the microwave frequency band are generally used for multi-channel, point-to-point communication. The disadvantages of microwaves are normally related to siting considerations. The distance between two adjacent radio stations may vary from a few km to over 50 km depending on the operating frequency, tower height and the intervening topography. In order to reduce propagation loss between two stations, a line-of-sight radio path is required. In cases where the topography between two stations is too rugged and the line-of-sight radio path is obstructed, or the distance between the two stations is too great, a repeater station is installed between them to relay communications. This requires additional land. The *Environmental Guidelines for- The Construction and Maintenance of Transmission Facilities* offers general mitigation and specific mitigation will be provided on a case by case basis. In most cases, these disadvantages will be outweighed by the advantages outlined below. The relative advantages and disadvantages will, however, be considered on a case-by-case basis.

Ontario Hydro presently has an operational microwave radio communications network in southern and part of northern Ontario, primarily for protection and control of the Bulk Electricity System (BES). The system operates in the 7

Gigahertz (GHz) band (7125-7725 MHz) which has been allocated by the Department of Communications (DOC) to all power utilities in Canada to be used on a primary, but non-exclusive, basis for protection and control of electricity systems. The advantages of microwave are:

*High Reliability* - A microwave radio system can be engineered to provide extremely reliable communications by such techniques as route diversity, space/frequency diversity, use of hot standby equipment, etc.

*High Capacity* - A maximum radio frequency bandwidth of 19.5 MHz per microwave link is allocated in the 7 GHz band.

Once the system is in place, up to 960 voice frequency channels can be accommodated easily and at relatively low cost if the proper intermediate frequency bandwidth in the radio equipment has been selected at the outset.

*Interference-free* - The 7 GHz is relatively free of interference from power line-related and other man-made noise sources. Although the band is shared with common carriers and the federal government for satellite communications, electrical utilities in Canada have been granted primary user status in this band by the DOC, thereby restricting other non-electrical utility users from placing new terrestrial services in this band.

*Independence from Power Lines* - Faults on power lines and system disturbances have no effect on microwave radio system.

*Relatively Independent from Weather Conditions* - Microwave radio systems operating in the 7 GHz band are not affected by rain or snow. Microwave radio links in excess of 50 km and traversing areas where propagation abnormalities are present can experience signal fading due to such factors as multi-path reflections, refraction, ducting, antenna decoupling, etc. However, this problem can be remedied by using such techniques as frequency/space diversity or employment of additional repeater stations.

*Costs* - Capital costs are generally lower than those of cable communication systems except for short distances. A larger number of circuits can be provided than is technically and economically possible using power line carrier (PLC) systems.

### **Power Line Carrier**

PLC systems utilize the physical paths formed by power lines interconnecting generating stations and load centres for transmission of information needed to manage and control complex electrical power networks. Generally, a PLC system consists of three distinct sub-systems:

(a) The high voltage line that must provide a satisfactory bearer medium for the high frequency signals between the terminal stations;

(b) The coupling equipment which serves as a means of connecting the carrier equipment to the high voltage line:

(c) The carrier equipment which is comprised of transmitters, receivers, power supplies and associated components.

Power line carrier equipment has been utilized in Ontario Hydro for many years and is still being used in remote areas of the province. A prime example is in northern Ontario. This bearer medium is primarily used for protection, control and voice communications in a power system.

In protection applications, the signals transmitted over the power lines must be capable of operating correctly during power system fault conditions which may affect signal transmission. Similarly, the noise generated by a line fault or switching operations must not cause false operation. These difficulties can be minimized by proper system design and a more complex relaying scheme and by using appropriate coupling techniques.

A properly designed and implemented PLC system can offer reasonably secure telecommunications over a long distance at a relatively low cost, but channel capacity is limited due to frequency congestion.

There are some disadvantages associated with PLC communications and they are summarized as follows:

- (a) *Limited Channel Capacity*: This is due to the limited frequency band available and system congestion;
- (b) *Affected by Environmental Conditions*: PLC system performance may be degraded by weather conditions such as snow, sleet, icing and rain;
- (c) *Affected by Power System Disturbances*: PLC system performance will be degraded by line faults and equipment noise;
- (d) *Interference*: Potential interference from and to other licensed users operating in the same frequency band. A PLC system operating in the same frequency band and in close proximity to a licensed high-power radio station may be susceptible to interference from the licensed station. PLC systems are not protected by the Federal Department of Communications (DOC) which ceased licensing such systems some time ago. If a PLC system interferes with a licensed radio user, the PLC system has to cease operation immediately upon notification by the DOC. If no alternative frequency can be found, and the interference cannot be eliminated, then the PLC system must be taken out of service.

The present technology does not offer a feasible solution to the disadvantages discussed above, but will be examined on a case by case basis.

### **Fibre Optics**

In digital fibre optic communications, the information to be transmitted is converted into a digital stream which then modulates a light source. The resulting string of light pulses propagate from the transmitting end of the fibre optic cable to the receiving end within the core portion of the glass fibre. At

the receiving end, a photodetector converts the light pulses back to their original electrical equivalent.

A variety of fibre optic cables are presently available in the marketplace. Of particular interest to Ontario Hydro is the composite overhead groundwire (OHGW) type. The composite OHGW is similar to the regular OHGW (referred to as shieldwire in Section 4.1.1) with the exception that glass fibres are imbedded inside the cable. When a composite OHGW is installed on a transmission line, optical fibres become available for telecommunications.

To communicate over long distances, repeater stations, usually spaced up to 60 km apart, are required to regenerate the transmitted signal. Prefabricated buildings, usually about 3 m by 3 m in size, are required to house the repeater equipment. In fibre optic systems using composite OHGW installations, the repeater buildings would likely be erected underneath or immediately next to a transmission tower on the transmission right-of-way. A distribution feeder line would also be required to provide low voltage electrical power to operate the repeater equipment. A short access road may have to be constructed to provide access to service the repeater station. Therefore, when selecting repeater sites, serious considerations would be given to locations where feeder lines and access roads are already available to minimize construction activities and associated costs. Due to its tremendous communications capacity, fibre optics has been widely utilized by power utilities both in the United States and Canada for administrative voice, data, video and power system applications. In the past few years, a large number of fibre optic systems of various lengths and capacities have been installed by the utilities and more are being brought into service. Ontario Hydro is considering developing a fibre optic network using mainly composite OHGW to interconnect its major generating and transformer stations for provision of both administrative and power system operation communications. If developed, the number of new telecommunication towers required in the future would be reduced.

### 3.2.3 Select System Options)

At this point in the study, the system options) which warrant further consideration are established. These options may have as their first stage:

- (a) A project which is to be implemented by the municipal utility or the direct customer.
  - (b) A project which is to be implemented by Ontario Hydro but which is exempt from the Environmental Assessment Act.
  - (c) A project which is to be implemented by Ontario Hydro and which falls within the class of projects defined in this document.
  - (d) A project which is to be implemented by Ontario Hydro and which requires an individual environmental assessment.
- If all of the remaining options fall under Category 1, the

utility/customer will be asked to carry out his own assessment of the options and to take appropriate action. If implementation of this local option will only defer the need for action by Ontario Hydro, the particulars will be filed and scheduled for review at a subsequent date.

If all of the remaining options fall under Category 2, Ontario Hydro will proceed in-house, again providing for subsequent review if the chosen option defers more major facilities by only a few years.

However, the usual case will be that at least one of the remaining options is a Category 3, or 4, project. If so, all options would be included in the environmental study which then follows.

Each option will be described in terms of:

- (a) The design and operational characteristics and requirements of the facilities usually required by such an option.
- (b) The manner in which Ontario Hydro usually acquires property rights for and constructs, operates and maintains those facilities. For the class of projects covered by this document, such descriptions are given in Chapter 4.

## 3.3 Environmental Analysis

### 3.3.1 Study Area Definition

A study area will be delineated to encompass the location of possible facilities required by the options) which warrant further consideration. The boundaries of the study area will be established by considering the system options in relation to the occurrence of known potential major environmental impacts and technical constraints. The environmental constraints may take the form of: ecologically sensitive areas, e.g., rivers, lakes, wetlands, man-made constraints, highways, urban centres.

Technical constraints may involve problems associated with construction and maintenance (e.g., flood plains, soil conditions) or interference with other facilities (microwave communication, radio transmission). Other boundary location opportunities may include such features as favourable property fabrics or existing severances. In some cases, the study process may include areas outside of the identified study area because of the potential for incurring off-site or indirect environmental effects.

### 3.3.2 Initial Notification

As shown on the schedule in Appendix H, the provincial ministries will be notified of the system need, the options and the area that Ontario Hydro proposes to study. Each ministry will be asked to comment with respect to ministerial policy in connection with the proposed options and study area. Appendix H contains the requirements for notifications as of December 1989. Ontario Hydro will also:

- (a) Publicly announce the project.

- (b) Notify each potentially affected local, county, regional, district and metropolitan municipality, and identify any of its official plan policies concerning environmental matters that may be affected by the project (such municipalities are to be considered as part of the "public"). For potentially affected areas without municipal organization, notify the local planning boards, if they exist.
- (c) Where the study area includes any part of the area under the jurisdiction of the Niagara Escarpment Commission, notify the Commission and take account of any features of the Niagara Escarpment Plan.
- (d) Notify any conservation authority which has jurisdiction over watersheds that may be affected by a project.
- (e) Notify Environment Canada if federal lands, mandates or interests may be potentially impacted.
- (f) Notify the Band Councils of any potentially affected Indian Reserves. Where non-Reserve Aboriginal or Metis communities may be potentially affected, notify appropriate Aboriginal and Metis organizations (e.g. the Ontario Metis and Aboriginal Association).

The initial notification given to the potentially affected and interested public and provincial agencies shall contain information on the system need for the proposed project, the options available, the area that Ontario Hydro proposes to study and the rights given to the public under this Class EA approval, including the bump-up provision, or advice as to how this information may be obtained.

If, after consultation with interested or potentially affected parties, there persists little or no public concern, a decision may be made to issue a single notification containing all the elements normally described in both the initial and final notification.

Initial notification will occur as early in the study process as is reasonable.

This notification will be issued upon the selection of the preferred alternative as shown in Figure 3-1.

For some projects eligible for the screening process (see Section 3.3.3), a modified initial notification/consultation process may be carried out on a case by case basis that is more appropriate to the minor environmental significance and scope of particular projects. Any such modifications will respect the intent of the notification process and Ontario Hydro's commitment to public consultation.

### 3.3.3 Screening Process

At this point, the physical parameters of a proposed undertaking will be defined sufficiently to determine if the undertaking might qualify as a Class project. The environmental situations likely to be significantly affected by the proposed undertaking will be also known at this time. Experience has shown that certain projects which appear to

qualify as Class projects, i.e., have the correct parameters, actually cause such insignificant environmental impacts that they do not warrant the depth of study associated with the process described in this document. Examples of such projects are:

- (a) Additional wood pole structures along existing rights-of-way.
- (b) Extension to existing distributing or transformer sites.
- (c) Replacement or relocation of steel transmission structures.
- (d) Installation of switches in existing transmission lines.

However, projects such as these cannot be grouped together arbitrarily and carried out under an exemption order; because, in some cases there could be environmental situations present which would warrant a detailed study. If these situations are very significant and cannot be avoided there exists the presence of a rare or endangered species, the project will proceed as a class environmental assessment or may be undertaken as an individual environmental assessment.

A screening process has therefore been developed to screen out proposed projects which would cause environmental impacts so slight as to be of no concern.

The following list of project types and project parameters define the subclass of undertakings eligible for the screening process:

- (a) Modifying or upgrading of existing transmission lines involving
  - (1) Replacement of no more than 25 suspension structures; and
  - (2) Installation of no more than 20 additional structures.
- (b) Minor overhead transmission lines up to 4 km in length.
- (c) Underground transmission lines in urban areas.
- (d) Modifying or expanding of existing transformer/switching stations involving a site extension of no more than 4 ha.
- (e) 115 kV distributing stations.
- (f) Telecommunications towers.

Ontario Hydro will use the screening process in consultation with directly affected government ministries, agencies, conservation authorities, municipalities, Band Councils, Aboriginal and Metis Associations such as the Ontario Metis and Aboriginal Association, special interest groups and the public in order to identify environmental concerns. Depending on the scope and nature of the project, this consultation may be considered to be the Initial Notification.

Information regarding the scope of the project and nature of the undertaking will be provided as part of the consultation process.

The criteria used in the assessment consists of a set of questions which, if answered "no", will allow the project to proceed without further study. If any of the questions are answered "yes" or "possibly", then the project will follow the study process described in this document.

The following provides a minimum list of criteria. Other factors will be considered if a potential concern is identified.

### Screening Criteria:

Determine whether the proposed undertaking will:

- (a) Conflict with the environmental goals, objectives, plans, standards, policy statements or guidelines adopted by the Province of Ontario or the community where the project is to be located.
- (b) Have significant effects on persons or property, including lands zoned residential.
- (c) Necessitate the irreversible commitment of any significant amount of non-renewable resources, including high capability agricultural lands.
- (d) Pre-empt the use, or potential use, of a significant natural resource for any other purpose.
- (e) Result in a significant detrimental effect on air or water quality, or on ambient noise levels for adjoining areas
- (f) Cause significant interference with the movement of any resident or migratory fish, wildlife species, or their respective habitats.
- (g) Establish a precedent or involve a new technology, either of which is likely to have significant environmental effects now or in the future.
- (h) Be a pre-condition to the implementation of another larger and more environmentally significant undertaking.
- (i) Likely to generate significant secondary effects, directly caused by Ontario Hydro's activities, which will adversely affect the environment.
- (j) Block pleasing views or significantly affect the aesthetic image of the surrounding area.
- (k) Significantly change the social structure or demographic characteristics of the surrounding neighbourhood or community.
- (l) Overtax existing community services or facilities (e.g., transportation, water supply, sanitary and storm sewers, solid waste disposal system, schools, parks, health care facilities).
- (m) Result in undesired or inappropriate access to

- (n) Create the removal of a significant amount of timber resources.
- (o) Result in significant detrimental affects to man-made or natural heritage resources.

If a directly affected party was not consulted during the Screening Process and that party subsequently raises a significant concern that cannot be resolved, Ontario Hydro will subject the project to the full study process described in this document. Should the concern be later resolved, Ontario Hydro may revert back to the Screening Process

Ontario Hydro will advise the Ministry of the Environment of all projects successfully screened.

### 3.3.4 Environmental Inventory

Environmental data is collected and mapped typically according to eight environmental factors; namely:

- (a) Agriculture Resources
- (b) Appearance of the Landscape
- (c) Biological Resources
- (d) Forest Resources
- (e) Heritage Resources
- (f) Human Settlement
- (g) Mineral Resources
- (h) Recreational Resources

Typical data types and sources within each of these factors are given in Appendix G

Based on past experience and studies, it has been determined that these environmental factors and data types address the key environmental issues associated with minor transmission facility planning. Typical environmental issues/concerns are presented in Appendix J and the *Environmental Guidelines for the Construction and Maintenance of Transmission Facilities*.

### 3.3.5 Identify and Evaluate Alternative Methods

To identify alternative methods such as route and/or sites, a set of guidelines or criteria are developed in relation to known environmental, technical, cost and socio-economic concerns. Alternatives are then identified using the guidelines, together with the environmental inventory and value judgements on the relative importance of avoiding the various mapped environmental data types.

An environmental, technical and cost evaluation is then carried out based on the potential quantitative and qualitative effects associated with each of the alternatives identified. Net environmental effects are addressed in the environmental evaluation by considering residual effects after mitigation is taken into account. Typical examples of potential mitigative measures are described in Appendix J and the *Environmental*

previously inaccessible areas.

### *Guidelines for the Construction and Maintenance of Transmission Facilities.*

#### **3.3.6 Select Preferred Alternative**

Using the results of both the quantitative and qualitative analysis of the alternatives, each of the alternatives is compared to each other by weighing the advantages and disadvantages in terms of environment, cost engineering, and system preferences. The quantitative analysis serves to highlight the range of relative differences among the potential effects for each alternative. The qualitative analysis describes the key issues or environmental problems and outlines other information such as mitigation that could minimize potential effects.

Subsequently, the preferred alternative selected should be the one with the most advantages and least disadvantages, all things considered.

#### **3.4 Public Involvement**

Individuals or groups identified at the outset as external or public participants will be provided ample opportunity for active participation in the study. Groups which may be invited to input include organizations concerned with the protection of heritage resources, and where native communities may be potentially impacted, native organizations and councils. Participation will be accomplished through an iterative process whereby information (collected in part from the public) is incorporated by Ontario Hydro. The result is subjected to input from the external participants, and modifications, if required as a result of the input, are made in turn by Ontario Hydro. This process ensures that public concerns are given full and fair consideration, and the result is generally acceptable.

The structure of the public involvement program will vary depending on the specific nature of the project, the size of the study and its geographical location. In all cases, an attempt will be made to identify the concerns of the people living in the area being studied and to take into account the environmental, social and economic impacts which they consider important.

To do this, use may be made of information centres) which are open to the general public to display and discuss various aspects of the study such as the scope of the study, the system options, the alternative selected, etc. Newsletters may also be used to ensure that the public is informed and has the opportunity to comment on the study. Where warranted, an external working committee comprised of representatives of organizations and groups with interests in the study area may be formed and involved in the study.

#### **3.5 Establish Acceptability**

##### **3.5.1 Final Notification**

Ontario Hydro shall give final notification to the provincial ministries and agencies which have indicated a continuing interest in the project and the directly affected and interested public. Final notification to the directly affected and

or some other form of personal type service. The notification shall include:

- (a) A description of the selected project.
- (b) Advice that comments on the selected project should be received within 30 days by a specified person in order to receive consideration.
- (c) Advice that environmental study information is available for inspection at specific locations.
- (d) The rights given to the public under this Class EA approval, including the bump-up provision, or advice on how this information may be obtained.

Bump-up requests received up to the end of the 30-day period will be recognized and considered.

##### **3.5.2 Assess Acceptability**

If there has been no expressed opposition, the selected project will be considered acceptable. It falls within the class definition, it becomes an undertaking as defined by this Class Environmental Assessment Document. Approval of the selected project under the EA Act is granted in accordance with the approved Class EA. Ontario Hydro may then apply for an order-in Council under the Power Corporation Act for property acquisition and/or construction of the facilities.

If there is expressed opposition to the selected project, Ontario Hydro will re-evaluate the rationale for the selection and will attempt to resolve the opposition. If the expressed opposition is subsequently resolved, then the project will be considered acceptable and will become an undertaking. If all expressed opposition cannot be satisfied, Ontario Hydro may decide to subject the project to an individual environmental assessment (i.e., bump-up).

##### **3.5.3 Review and Decision by the Minister of the Environment**

If Ontario Hydro cannot satisfy all expressed opposition, the objectors) requests a bump up, and Ontario Hydro considers a redesignation of the project to be inappropriate; then the written objection and bump-up request along with Ontario Hydro's response and draft environmental study report will be forwarded to the Minister of the Environment for a decision as to whether or not the project requires an individual environmental assessment. A copy of the letter to the Minister of the Environment and Ontario Hydro's response will be sent to the objectors) at this time.

- (a) After considering the objection and Ontario Hydro's response, a decision will be made by the Minister of the Environment, normally within 30 days of receipt of the bump-up request by the minister.
- (b) If the decision reached indicates that the objection does not warrant bump-up of the project to an individual environmental assessment the Minister of the Environment will inform both parties and the



interested public will typically be carried out by direct mail

project may then proceed.

- (c) If the decision reached is to bump-up the project, then the objector and Ontario Hydro would be provided with the rationale for requiring an individual environmental assessment. Ontario Hydro would then be required to submit an individual environmental assessment or withdraw the project. Should the objections be resolved and Minister of the Environment agrees, the planning process will resume at the point the objection occurred. Any decision by the Minister may be subject to conditions.

Ontario Hydro will attempt to identify concerns as early as possible in the study process in order to maintain maximum flexibility to resolve any such concerns during the study process.

### 3.6 Environmental Study Report

An Environmental Study Report (ESR) will be prepared for each project subjected to the study process described in Sections 3.1 to 3.5. Upon completion of the environmental study, the ESR will be filed with the Ministry of the Environment, for information purposes. Copies will also be forwarded to Ontario Hydro's local area office, elected and appointed officials, and any organization or individual that requests one.

Prior to filing the ESR, the information will be available for review by any interested party during the period of final notification. The information will normally consist of the following:

- (a) A description of the undertaking.
- (b) A description of, and the need (justification) for the project.
- (c) The location of the selected project.
- (d) The expected effects on the environment.
- (e) The alternatives, mitigation and predicted net effects.
- (f) A description of any required environmental monitoring.

Concerns raised during the study will be noted in the ESR, along with how they were addressed.

### 3.7 Subsequent Communication with the Public

The acceptance of a selected project under this process does not end communications between Ontario Hydro and the public.

Provisions for subsequent communication with individuals whose property is affected by an undertaking are detailed in Appendix I.

### 3.8 Monitoring

Ontario Hydro has been monitoring the effectiveness of the *Environmental Guidelines for the Construction and*

*Maintenance of Transmission Facilities* on transmission projects with both station and transmission line work which have had either an individual or class environmental approval and on which field work started after January 1, 1981. Details of the monitoring program are contained in the guidelines.

### 3.9 Addendum to an Environmental Report

It may not be feasible or even desirable to implement the undertaking in the way originally planned and documented in the ESR. This may come about as a result of a change in conditions, the development of new technology or mitigation measures or the appearance of previously unidentified concerns. Where a change to the commitments outlined in the ESR is determined, affected parties will be consulted. If, through such consultation, significant environmental implications are identified, an addendum will be prepared.

This addendum will document the circumstances necessitating the change, the environmental effects caused by the change and what can be done to mitigate any negative impacts.

The addendum will be filed with the Ministry of the Environment and notice of filing will be provided to all affected parties. Copies of the addendum will be available to affected parties upon request.

Fifteen days will be allowed for affected parties to review the change and register any objections or concerns. During this time no work will be undertaken which might adversely affect that part of the project under review unless all affected parties have reached agreement that the 15 days for documentation and review are not required. Where there is no response within the review period, acceptance will be assumed.

When the proposed change is in response to an emergency situation during construction or where a delay in the implementation of the change would result in detrimental environmental effects, the change would be implemented without delay and affected parties would be contacted. An addendum would subsequently be prepared for significant changes and filed.

If expressed opposition is received during the 15 days and cannot be satisfied, the process described in Section 3.5.3 will be followed.

### 3.10 Amending this Class Environmental Assessment Document

Ontario Hydro may apply for amendments to this Class EA at any time for the purpose of:

- (a) Clarifying any portion of the document or process.
- (b) Improving the efficiency or the effectiveness of the process described in the document.
- (c) Extending the Class EA to projects that may not have been previously included in the class definition.



In order to facilitate the above, the following three-step process will be followed:

- (a) The change will be described in detail, justified with additional support material as necessary and submitted to the Minister of the Environment for his consideration.
- (b) The minister will review the information presented and, if satisfied that the request is reason-able will

direct Ontario Hydro to issue a notice to the public as well as any potentially affected provincial ministry, agency or municipality, and allow 30 days for comments.

- (c) On the basis of comments received, the minister may approve the change and declare that the change be made under Section 7(3) of the Environmental Assessment Act.

## 4

### Description of Projects Covered by the Class Definition

This chapter describes the physical components and activities associated with the projects covered by this assessment. Construction, maintenance and right-of-way management activities will be carried out in accordance with the Environmental Guidelines for the Construction and Maintenance of Transmission Facilities.

#### 4.1 Transmission Lines

Ontario Hydro usually transmits electrical energy via overhead lines, except in densely populated areas where underground transmission lines may be used. The decision as to which will be used for a specific undertaking is dependent on the overall environmental implications and cost of each.

##### 4.1.1 Overhead Transmission Lines

An overhead transmission line has six basic components, each of which may vary with respect to design and material depending on the specific requirements for the line and its intended location. The components, along with their function and material options, are as follows:

- (a) *Conductors:* To provide continuous electrical pathways (circuits) between points of supply and use. Stranded aluminum steel-reinforced, stranded aluminum, stranded copper.
- (b) *Shieldwires:* To shield conductors from lightning and carry fault current. Galvanized steel, copperweld, alumoweld. Composite cable incorporating fibre optic telecommunication capability may be used.
- (c) *Structures:* To support conductors at a safe elevation above ground. Steel lattice, steel pole, wood pole.
- (d) *Foundations:* To support structures. Steel grillage, reinforced concrete, steel or wood piles with suitable cap.
- (e) *Insulators:* To isolate conductors electrically from their supporting structure. Porcelain, polymer or glass.
- (f) *Counterpoise:* To reduce the susceptibility of the line to outages caused by lightning. Galvanized steel, copper.

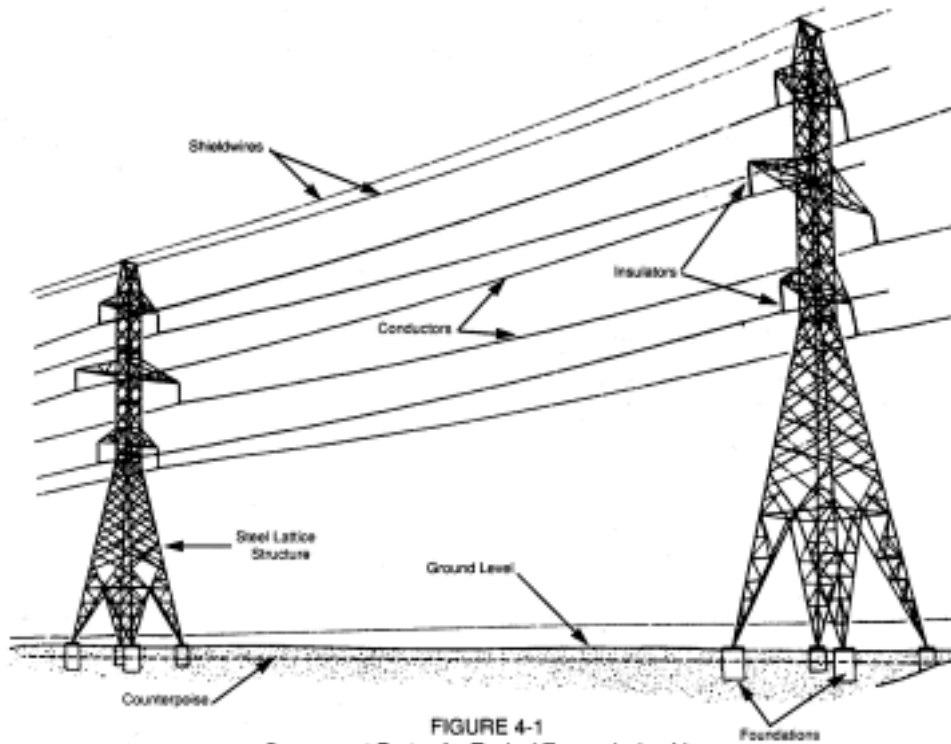

Transmission lines in Ontario usually consist of aluminum conductors steel-reinforced, galvanized steel skywires, steel lattice structures, reinforced concrete foundations, porcelain insulators and galvanized steel counterpoise wires. Figure 4-1 shows a span of a typical line and identifies its component parts. If the line includes fibre optic telecommunications capability, small buildings to house repeater equipment may be erected along the line, typically spaced up to 60 km apart.

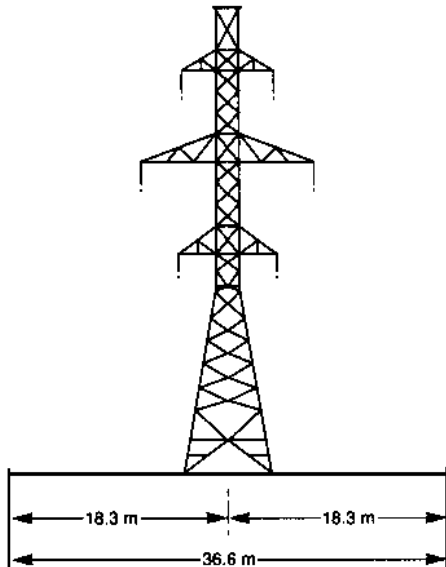

**Figure 4-2**  
**Typical right-of-way Width for a 230 kV Two-circuit Transmission Line (Narrow-base Single Footing Towers May be Used in Cultivated Fields of Prime Farm Land)**

**Right-of-Way Requirement**

A typical right-of-way width to accommodate a two-circuits 230 kV tower line is shown in Figure 4-2. The actual widths required for specific rights-of-way vary because of such factors as span length, conductor size and sag, the location of danger trees, the need for helicopter patrol or the need for fall-free spacing.

**Right-of-Way Acquisition**

Rights-of-way for transmission facilities are acquired in accordance with the policy established for property acquisition. Under this policy owners are given the full (pulleys) attached to each tower. Being under tension, the protection of the Expropriations Act. Easement rights are generally acquired for transmission line rights-of-way except where the fee (full ownership) is required by Ontario Hydro or where a severance is acceptable to the municipality.

**Construction Activities**

The major operations in the construction of overhead transmission lines include the selective cutting of trees along

the rights-of-way, establishment of construction access routes, the installation of tower foundations, the assembly and erection of towers, the stringing of conductors, the installation of counterpoise, and clean-up and restoration of the right-of-way. Construction may be carried out either by Hydro's construction staff or by contract forces.

Construction practices will comply with the *Environmental Guidelines for the Construction and Maintenance of Transmission Facilities*. As part of the guidelines, specific instructions may be issued where environmentally sensitive situations are identified through the planning or construction phases as set out herein. In such cases, the specific instructions will govern.

*Access Routes:* To construct a transmission line, it is necessary to have access to the right-of-way for the construction equipment and line materials. Wherever possible, existing roads and lanes are used and resulting damage is repaired when construction activities are completed. Where access roads for Ontario Hydro vehicles have to be constructed, their location is determined by Ontario Hydro in conjunction with the concerned owners and applicable authorities, e.g., conservation authorities, Niagara Escarpment Commission or others. The environmental impacts caused by access roads will be considered as part of the study.

*Tower Foundations:* The type of foundation installed at any given site is dependent on both the type of soil and the type of tower to be built. Soil tests are carried out to determine soil strength for foundation designs. The majority of foundations in earth will be augered reinforced concrete. In weak soils, piles may be required. Those in rock will have steel rods drilled and grouted into the rock and a small pad of concrete placed on top. Foundations for towers which will be used at angle or terminating positions are larger than those required for suspension towers.

Equipment such as augers, backhoes, concrete trucks and compressors may be used in foundation construction.

Excavated material is either removed from the site or spread in a suitable location.

*Tower Assembly and Erection:* Tower steel is delivered via the access routes to the sites where it is assembled to form tower sections which are usually lifted into position by a crane.

*Conductor Stringing:* The stringing of conductors can be done in two ways: slack stringing in which the conductor is pulled along the ground and placed in travellers at each tower before being tensioned, or tension stringing in which the conductors are pulled under tension through travellers conductors are kept off the ground at all times. The first step in tension stringing is to install the insulator strings and travellers on the tower arms. That is followed by installing a light rope along the section of line to be strung; stringing sections can be as long as 10 km. A helicopter is normally used to fly the rope along the right-of way for deposit in the travellers. This rope is then used to pull in larger ropes and steel cables until one of sufficient strength has been strung to pull through the conductors.

After all the conductors are pulled into place by this method, they are tightened to a specified tension. This tension ensures that the line maintains the correct ground clearance under the operating conditions for which the line is designed. The conductors are clamped at each tower and damping devices are installed on them to limit vibration. Skywires are attached at the tower peak positions above the conductors and are strung in a similar manner.

Specialized equipment is required for tension stringing. The equipment is moved along existing roads wherever possible, thus avoiding the need to move heavy equipment along the full length of the right-of-way.

*Counterpoise:* To ensure that a transmission line will operate efficiently when in service, it is necessary that the electrical ground resistance at each tower be low. To accomplish this, a ground electrode is installed at each tower. If, because of soil conditions, the ground resistance is too high, additional grounding must be installed.

The normal procedure is to bury two continuous wires along the right-of-way, one on each side of the towers. These wires are normally buried to a depth of 460 mm in cultivated ground and 200 mm in bush areas and in rocky ground, if possible. The wires are installed by a tracked vehicle which carries the ground wire on reels and buries it by means of a plough attachment as it proceeds along the right-of-way. The wires are then connected to each tower.

*Clean-up:* The final stage of construction is the clean-up of the right-of-way to be sure that all construction materials have been removed. This is an ongoing procedure during the construction of the line, but a final clean-up is also carried out. In addition, any necessary restoration to the right-of-way (i.e., work sites, fences, roads, etc.) is completed and the woodlots are seeded. All erosion sites are stabilized and screen plantings are established as required on the right-of-way.

#### ***Transmission Line Maintenance***

Maintenance of transmission lines is required to ensure acceptable performance of the line components over time and to repair damage due to accidents or unusual climatic conditions. This involves periodic patrols and/or inspections. Specific maintenance programs have been developed and are carried out on a regular basis.

*Routine Maintenance:* Planned repairs of a localized nature which usually take over one-half to one day to complete are carried out to avert potential problems. These repairs may require trucks to be moved to the repair site. The frequency of such repairs is approximately once each year for every 160 km of line.

There are also major maintenance items such as replacement of skywire and the lowering of tower footing resistance along a line. These items are usually of such a nature as to permit long-range planning, and they can usually be scheduled to minimize inconvenience to property owners.

*Emergency maintenance:* Emergency repairs must be carried out as quickly as possible. It may take one-half to one day to replace a string of broken insulators or several days to replace structures damaged by ice storms or tornadoes. Heavy equipment and materials are usually required to replace structures during emergency situations, and mitigating measures will be taken as soon as possible to repair any damage.

#### ***Right-of-Way Management***

Right-of-way management practices reflect provincial and legislative requirements and are designed to ensure the long-term safety and reliability of the line and protection of the environment.

The management practices are carried out in accordance with general and site-specific management specifications which identify the best treatment methods.

#### ***Management Activities***

*Line Clearing:* Involves the pruning or removal of woody vegetation near the conductors so that a specified minimum clearance is maintained.

*Patrols:* Inspections done at regular intervals to identify and correct situations which cannot be left until the next regular maintenance operation.

*Grounds Maintenance:* Includes activities such as grass cutting, weed spraying and snow ploughing done in order to keep Ontario Hydro properties in a visually acceptable and safe condition.

*Vegetation Control:* Involves the control of woody vegetation in order to ensure that circuits are not interrupted and public safety is maintained. Methods currently used are herbicides, hand cutting, and machine mowing. Selective removal of incompatible woody vegetation is practiced to promote the development of low growing stable plant communities.

*Stabilizing or Restoring The Environment:* Erosion sites are identified and controlled by vegetative or mechanical methods.

*Secondary Use of Ontario Hydro Property:* Secondary use requests are granted when practical, where they do not cause conflict with the adjacent property owners, and where they will not interfere with Ontario Hydro's use or projected use of the right-of-way or endanger any facilities. A Procedural Document has been prepared in accordance with the *Environmental Assessment Act* whereby secondary land use proposals are assessed. Garden plots, access roads to cottages, horseback riding trails, parking lots, utility pipelines, etc., are some of the secondary uses of Ontario Hydro rights-of-way that may be permitted and where agricultural use is possible, it is encouraged.

## 4.1.2 Underground Transmission Lines

### Physical Plant Options

*Self-contained, Low-pressure Liquid filled Cable:* Each underground circuit consists of three separate cables, each consisting of a concentric stranded copper or aluminum conductor with a hollow core, insulated with paper tapes and sheathed with either lead or aluminum. After sheathing, the cable insulation is thoroughly dried under vacuum to remove moisture, and the cable is then filled through its hollow core with a degassed liquid which fills any voids which might exist in the insulation. Reservoirs which exert a slight positive pressure on the cable liquid are connected to the cable. The cable sheath is protected against corrosion by a suitable covering. When the cable is heated by current flowing through it, the liquid expands and flows through the hollow core to the reservoirs at the cable terminals. When the cable cools and the liquid contracts, it is forced back into the cable by pressure on the reservoirs. Thus a positive pressure of moderate magnitude is kept on the liquid at all times, preventing the formation of voids in the insulation which could ionize under electrical stress and result in breakdown of the cable insulation.

Self-contained, low-pressure, liquid-filled cables can be directly buried without being encased in either a duct or pipe. It is, however, necessary to surround the cables with a material which will permit uniform heat dissipation along the length of the cable to reduce the probability of hot spots developing and permit optimum utilization of the current-carrying capacity of the cable. Ontario Hydro usually surrounds directly buried high-voltage cables with an envelope of finely crushed stone. These cables are protected against mechanical damage by concrete slabs placed over them.

*Self-contained, Low-pressure, Liquid filled Cables Installed in Ducts:* These cables are identical to those used for direct bury, but instead they are installed in cable ducts which are encased in concrete. Cable splices are usually contained in permanent reinforced concrete manholes (underground vaults) which are positioned along the route at suitable locations.

*High-pressure, Liquid filled Pipe-type Cable:* This type of cable relies on high pressure acting on the cable insulation to suppress the formation of voids which could ionize and result in electrical failure of the insulation. The cable consists of a stranded copper or aluminum conductor insulated with liquid-impregnated paper tapes, and protected against installation damage by a skid wire helically wound over the cable. Three such cables to form one three-phase circuit are pulled together into a steel pipe which is then filled with degassed liquid and maintained at a constant pressure of approximately 1.4 MPa. Since the three cables are close together in the pipe, mutual heating effects are more pronounced than with self-contained cables, and consequently a larger conductor for the same current-carrying capacity is required.

*Polymeric Cable:* These cables use solid polymeric insulation, e.g., cross-linked polyethylene. Such cables are proving to be reliable in applications in Europe and Japan and

may be used in Ontario. Their installation would be very similar to direct-buried, self-contained, low pressure, liquid-filled cables.

### Right-of-Way Requirements

For cable circuits designed to operate at voltages up to and including 230 kV, the right-of-way requirement depends on the proposed location as follows:

- (a) *City Streets:* Where a circuit is to be installed in urban areas and will essentially be located within road allowances, sufficient working space for its installation is provided by the road allowance itself. Only physical space is required to install a circuit between or adjacent to other underground utilities, plus sufficient clearance to enable repair work to be carried out on either the cable circuit itself or the utilities adjacent to it. A clear space of 3 m will usually suffice to enable a single underground cable circuit to be installed regardless of the type of cable being used. Where more than one circuit is required, the circuits are generally located on separate routes to reduce the probability of coincident outages, and also to optimize their efficiency by preventing mutual heating occurring between them.
- (b) *Private Right-of-way:* The right-of-way required to accommodate a single-circuit, high-voltage cable circuit on a private right-of-way is dependent on the necessary working space for its installation and maintenance. In general, for single circuits utilizing one conductor per phase, a right-of-way width of 4.5 m will suffice.

For multiple circuits or for single circuits utilizing more than one conductor per phase, additional right-of-way width is required to provide for thermal independence of the circuits and varies according to the design of the circuits and the manner in which it is intended they be operated. Such right-of-way widths would be determined individually for specific cases. *As an example:* A two-circuit, 230 kV, high-pressure, pipe type installation equivalent in current carrying capability to a two-circuit, 230 kV, overhead line with a single 1843 kcmil copper conductor per phase would require a right-of-way width of approximately 15 m. A two-circuit, 500 kV, low-pressure, liquid-filled cable installation to be equivalent to a two-circuit, 500 kV, overhead line with a four-conductor bundle of 585 kcmil conductors per phase would require three, 3800 kcmil conductors per phase and a right-of-way width of 30 m.

### Construction Methods

*Self-contained, Low-pressure, Liquid filled Cables Directly Buried:* The general method of installing a directly buried, liquid-filled cable circuit involves opening a trench approximately 1.2 m wide by 1.2 m deep along the proposed route between predetermined jointing positions which are usually spaced approximately 300 m apart. Depending on the location of the trench and the soil characteristics, it may be necessary to either partly or completely shore the sidewalk

of the trench to prevent their collapse. The trench itself is generally excavated by a backhoe and if the route is along city streets, the pavement is first cut with a suitable saw along the outside edges of the proposed trench. Excavated material is either trucked away to a suitable dump or if all or part of it is intended for reuse, it is transported to a temporary storage site (if it cannot be stored along the trench).

The trench is carefully cleared of all debris, and concrete sidewalk approximately 0.3 m high are constructed, if they are deemed necessary. A cushion of crushed stone screening is then installed at the bottom of the trench and compacted by tamping. Cable rollers are then positioned along the bottom of the cable trench and the three cables installed one at a time. To install a cable, a win truck is set up at one end of the trench and a reel containing the cable at the other. The steel win cable is drawn along the trench over the cable rollers and fastened to a pulling eye at the end of the cable to be pulled into the trench. In some instances, the cable is pulled in by attaching it at regular intervals to a messenger cable, rather than pulling directly on the pulling eye at the cable end. After the cable has been pulled into the trench, it is removed from the rollers and positioned into the trench, and the pulling operation is then repeated for the second and third cables. When all cables have been installed and tested for soundness, they are then covered with crushed stone screenings which are compacted by tamping, and a precast or poured concrete cover is installed overall. During installation of the cables in the first section of trench, a second section is being opened and the jointing position prepared for cable splicing.

By the time cables have been installed in the second section, a third section has been opened, and the backfilling of the first section has commenced. It is therefore apparent that when installing directly buried cables, there is usually a trench length of approximately 900 m over which activity of some kind is taking place at any given time for a period of up to six weeks. Since such an operation is very disruptive in built-up areas, directly buried cable circuits are not considered particularly suitable for urban installation.

*Self-contained, Low-pressure, Liquid filled Cables Installed in Ducts:* This type of cable system uses the same cable as used for directly buried installations. Construction methods differ in that concrete enclosed ducts are constructed in the cable trench, and permanent concrete manholes are constructed at the jointing positions. When constructing the duct bank, it is not necessary to have such long sections of trench open at any given time. The equipment used for construction of the duct bank and installation of the cables is essentially the same as that used for directly buried cable, but there is not a requirement for a full length of trench between jointing positions to be open. The current-carrying capability of cables installed in ducts is somewhat less than that of the same cables directly buried due to the difference in heat transfer capability of the air surrounding the cables in the duct, and the duct itself, relative to the crushed stone screenings which surround the directly buried cables.

*High-pressure, Liquid filled, Pipe-type Cable:* This type of cable system involves installation of a steel pipe approximately 1 m below grade into which three insulated conductors are drawn. The length of conductor drawn into a section of pipe may be several hundred metres and is

dependent on the number and severity of the vertical and horizontal bends.

Construction procedures involve proving out the feasibility of the proposed grade of the pipe between proposed manhole locations by digging testholes at strategic positions, construction of reinforced concrete manholes at jointing locations, installation of the pipe, installation of the cable, construction of a pumping plant at one end of the cable circuit, jointing the cable, and filling the pipe with degassed liquid.

The construction of a manhole necessitates excavation and shoring of a hole of sufficient size to accommodate the manhole. The length, width and depth of a manhole for a single circuit of pipe-type cable is approximately 5.8 m by 2.5 m by 3.7 m. After excavation, the manhole is formed, reinforcing steel positioned and concrete poured.

Pipe installation requires a trench approximately 1 m wide to be excavated to a depth of approximately 1.2 m. Excavated material is removed from the site unless it can be stored along the trench and reused. A bed of crushed stone screening is then placed in the trench and compacted into a layer approximately 150 mm thick. Coated steel pipe, generally 150 mm or 200 mm in diameter (depending on the conductor size and voltage level of the cable being installed) and in lengths up to 12 m, is then positioned in the trench on suitable supports, and the pipe lengths are welded together to form a continuous pipe. After welding, the supports are removed and the pipe centered on the bed of crushed stone screenings. The pipe is then covered to a depth of approximately 150 mm with crushed stone screenings. This material may, in some instances, be used to completely fill the trench, particularly if it is located in a roadway. Reinstatement of the trench at ground level to the condition which existed prior to excavation is then carried out.

After the pipe is installed and manholes constructed, cable installation takes place.

Three cables yoked together are pulled into each pipe section between manholes by a truck-mounted win. The cable splices are then made in the manholes.

A prefabricated enclosed pumping plant located at one end of the cable installation, either within a transformer station or on property acquired for it, is used to fill the pipe with liquid and to maintain a constant liquid pressure of approximately 1.4 MPa.

Construction equipment associated with pipe-type cable installations consists of trucks, backhoes, concrete trucks, pipe benders, generators, winches and other construction equipment normally associated with the construction industry.

#### ***Operating and Maintenance Procedures***

*Self-contained, Liquid filled, Directly Buried Cable:* Once this type of cable is installed very little of it is visible or readily accessible. Operating and maintenance procedures are generally associated with checking the liquid reservoir pressure gauges and liquid piping at the cable terminations,



and inspecting cable joints in those cases where they are contained in permanent manholes. It is also customary to periodically patrol the cable route so that any new excavation work which might endanger the cable circuit can be watched closely and contractors made aware of the cable's precise location. In the event of a cable failure, the location of the fault is determined electrically, if necessary, and the cable is excavated and repaired. This is usually a very time consuming operation and may take several weeks to complete.

*Self-contained, Liquid-filled Cable-duct and Manhole Installation:* As with directly buried cables, routine operating and maintenance procedures involve the checking of components at the cable terminations and in the manholes. In the event of a cable fault, it may be possible to withdraw the faulted cable section, provided the duct has not been severely damaged by the fault. If the cable could not be pulled out, it would be necessary to locate, excavate and repair the cable duct, and repair or replace the cable.

*High-pressure, Pipe-type Cable:* The heart of a high-pressure, pipe-type cable system is the pumping plant which supplies and maintains the pressure necessary to prevent the formation of voids in the cable insulation where ionization of gases would result in insulation failure. The pumping plant is equipped with dual pumps, and in the event of a pump failure, the duty of the failed pump is automatically assumed by the second pump. There is also an automatic alarm system which alerts the controlling station whenever there are problems associated with the pumping plant.

Maintenance procedures require the periodic checking of all automatic systems to ensure they are functioning properly, a route check to spot any potential hazards to the cable system, and an inspection of the jointing manholes.

The electrical insulating fluid will either be a polybutane, dodecylbenzene, or synthetic fluid, and be non-toxic, low viscosity with a high flash point. It is also biodegradable over the long term.

## 4.2 Transformer Stations

### 4.2.1 General

A transformer station of the type covered by the class definition usually has four basic components, namely:

- (a) One or more high-voltage areas ( 115 kV or greater).
- (b) One or more transformer areas.
- (c) One or more low-voltage areas (less than 50 kV).
- d) A control, meter and relay area.

Figures 4-3 and 4-4 illustrate schematically the interrelationship of the first three basic components. The fourth component - the control, meter and relay area, serves as an overall monitor and control for equipment in the three other types of areas in the transformer station.

### 4.2.2 Basic Operation

The basic operation of the typical transformer station shown in Figure 4-3 is as follows:

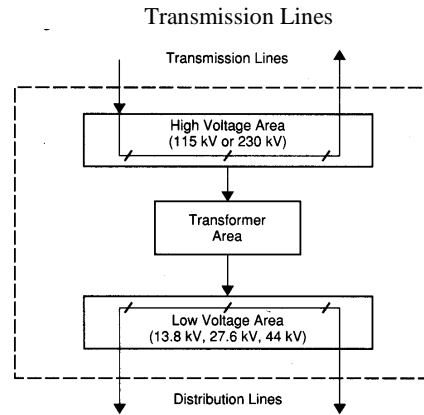

**Figure 4-3**  
**Components of a Typical Transformer Station Simple**

Electrical energy enters the station from the power supply system through incoming transmission lines which terminate in the high-voltage area. Within this area are electrical conductors and electrical switches which connect the incoming lines to the transformers in the transformer area. In this simplest form of station, there could also be other conductors and switches which connect the lines together.

The electrical energy is directed to the transformer area where its voltage level is changed by transformers from 115 kV, 230 kV or 500 kV to a lower voltage. The electrical energy at the lower voltage is then directed through electrical conductors from the transformer area to the lower or low voltage area (i.e., below 50 kV). In the low-voltage area, the energy is directed through conductors and switching devices to subtransmission or distribution lines.

The flow of energy through the station is controlled and monitored by equipment located in the control, meter and relay area. Certain of the control functions are initiated by operation action, others are initiated by automatic features designed to protect the station and/or line equipment in abnormal circumstances.

The operation of the complex station, shown in Figure 4-4, is essentially the same as the simple station, except that there are more conductors and switches to permit a flow of energy between the various lines connected to each high-voltage area and also between the high-voltage areas.

### 4.2.3 Alternative Designs

Transformer stations may be of either an outdoor design, where all or most of the major equipment is located in the

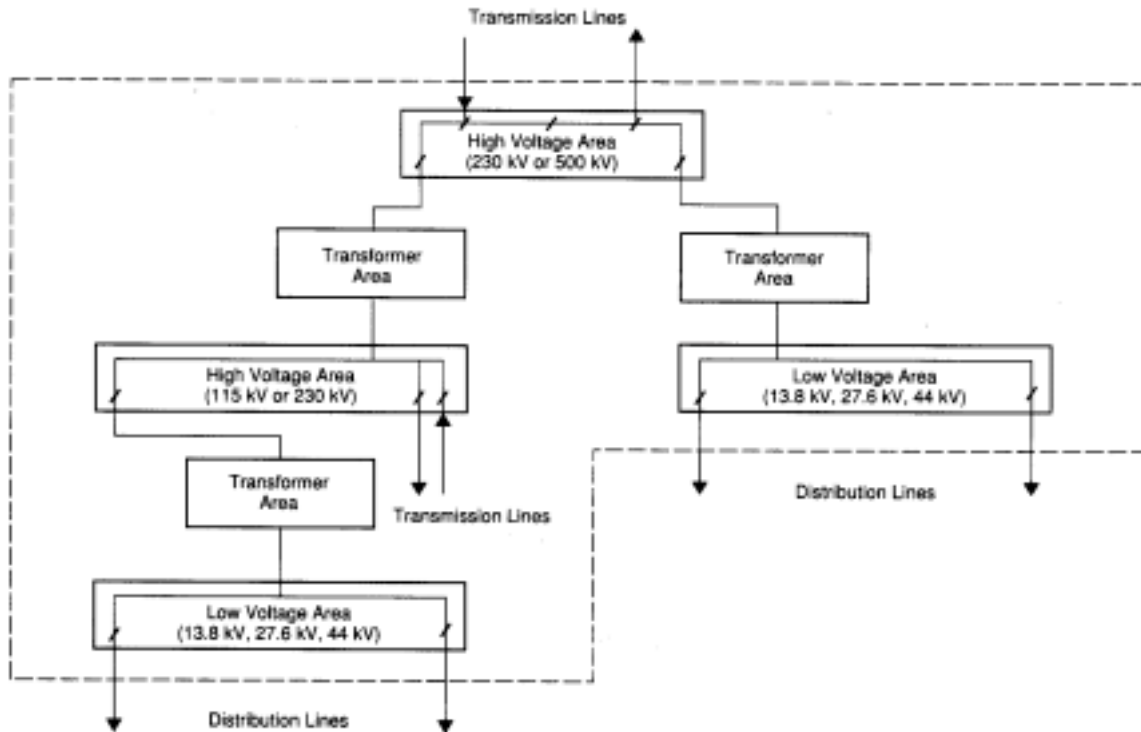

**Figure 4-4**  
**Components of a Typical Transformer Station - Complex**

open within a fenced-in area, or an indoor design, where the equipment is contained within one or more buildings.

With the outdoor design, the equipment in the high-voltage, transformer and low-voltage areas is usually supported on concrete foundations and/or structural steel. The control, meter and relay area is contained within a single-storey building. In some cases, one or more of the high-voltage or low-voltage areas may be contained in a separate building within the fenced area.

There are two basic types of outdoor stations generally in use, one which uses lower structures but requires more land and one in which the structures are higher but less land is required.

All components of an indoor design are contained within one or more multi-storey buildings which are designed to be as compatible with the surrounding environment as possible.

The area outside a station is landscaped as appropriate to make it more esthetically compatible with its surroundings. Lines connected to the station may be either overhead or underground.

#### 4.2.4 Site Requirements

The site area needed for a simple regional supply transformer station (Figure 4-3) typically varies from 0.2 ha for an indoor urban station to 4.5 ha for an outdoor station.

The area needed for the more complex combined regional supply and system interconnecting transformer station is typically about 22 ha.

The actual site size will vary depending on the availability of land, the type of station facilities installed, the number and orientation of the transmission lines, the character and use of adjacent properties, and the amount of land required around the station for landscaping. The site size may also be affected by local bylaws governing the area.

Sufficient land is acquired to accommodate the maximum facilities foreseen for the particular station. The station is usually constructed in stages toward that maximum as the need develops.

A level, well-drained area with good soil bearing qualities is desirable for the station site. The station must be located such that heavy transformers can be transported to the site. It is desirable to locate complex stations with large

transformers needed to interconnect high voltage switchyards, adjacent to a railway and /or build a spur line into the station.

#### **4.2.5 Station Equipment**

##### ***High-Voltage Area***

The high-voltage area may contain circuit breakers (high interrupting capability switches), load interrupting switches, disconnect switches and interconnecting bus work, as well as auxiliary equipment such as current and voltage transformers, lightning arresters and spark gaps.

The circuit breakers are used to control the flow of energy by opening to interrupt or by closing to initiate the flow of electrical load current through particular conductors. Circuit breakers also have the capability to interrupt large currents which may be experienced under abnormal conditions.

The three common types of circuit breakers are:

- (a) A bulk-oil design with the electric current carrying and switching parts immersed in oil inside a grounded steel tank.
- (b) An air-blast design where the electrical parts are located in an air-filled pressure tank located on top of steel-supported porcelain insulators.
- (c) A gas circuit breaker where the current carrying and switching parts are located within a metal cylinder containing insulating gas such as sulphur hexafluoride (SF<sub>6</sub>).

The load interrupting switches are also used to interrupt and initiate load currents. However, they have only limited capability to interrupt abnormally high currents.

The disconnect switches which have virtually no current interrupting capability are used to isolate a piece of equipment from the system for maintenance purposes.

The load interrupting and disconnect switches may be of two types: an air-insulated unit with the electrical conductor and current-carrying parts mounted on steel-supported porcelain insulators to isolate it from the ground, or a gas-insulated (e.g., SF<sub>6</sub>) unit in which the conductor and the current-carrying parts are located within a grounded aluminum or steel cylinder containing the insulating gas.

The interconnecting bus work connects together the major components in an area and connects one area to another area. The bus work may be of either rigid or flexible conductors, mounted or suspended from steel-supported porcelain insulators or rigid conductors supported within a sealed metal cylinder filled with gas (SF<sub>6</sub>).

The auxiliary equipment (current and voltage transformers, surge arresters, spark gaps) are connected to the equipment or bus work and are used for the protection, control and monitoring of the station.

Outdoor stations may also contain a limited number of lightning protection towers to protect the station from lightning strikes.

##### ***Transformer Area***

The transformer area contains one or more transformers which are used to change the voltage of the electrical power from one voltage level to another.

Each transformer consists basically of a steel tank containing electrical windings immersed in an oil bath. The conductors enter the tank through porcelain bushings on top of the tank. The oil, which acts as an electrical insulator and as a coolant, circulates through the transformer and cooling radiators mounted adjacent to the transformer. Oil pumps may be used to circulate the oil, and fans are used to force air through the radiators to increase the amount of cooling. Pits are constructed under all power transformers to contain possible oil spillage. The pits are filled with gravel to restrict oxygen to spilled oil to inhibit combustion in the event that the oil should be ignited.

All energized transformers produce a low-frequency sound. To ensure that the lowest ambient sound level at nearby residences will not be noticeably increased by the normal operation of the transformer, precautions are taken through the design of the transformers, their location within the station and the use of acoustical barriers.

The regional supply station usually starts with two power transformers in the first stage. As requirements develop, the station expands to a maximum of four or six units in the ultimate development. Each pair of transformers is usually connected to its own low-voltage area.

##### ***Low-Voltage Area***

The low-voltage area contains disconnect switches and circuit breakers interconnected by rigid conductors supported on porcelain insulators and auxiliary equipment such as voltage and current transformers. The equipment may be located outdoors and supported on structural steel and/or concrete foundations or contained within an enclosure. The devices are used to perform the same general function as described for the high-voltage area.

##### ***Control, Meter and Relay Area***

The control, meter and relay area contains all the control, meter and relay equipment required to operate and control the complete station. This equipment is connected by electrical cables to the specified devices, e.g., circuit breakers, disconnect switches, current transformers located through the stations.

Washroom facilities are also located in this area. The sewage disposal system is designed to local and provincial regulations and usually consists either of an on-site disposal system or a direct connection to a municipal system. Water supply is either from an on-site well or from a municipal source.

If the station is of the outdoor design, the control, meter and relay equipment is contained within one or more single-

storey buildings. For indoor stations, this equipment is contained in a room within one of the station buildings.

#### **4.2.6 Construction**

The first step in the construction of a station is to grade the site to provide a level area for installation of structures and buildings. Top soil is removed and stockpiled at the site for landscaping purposes. Surplus soil is disposed of in an approved landfill area.

After the grade is established, drainage and septic systems are installed and a fence is erected around the construction area. In the case of outdoor stations, this may be a chain link fence which will form part of the permanent fencing. In the case of indoor stations, temporary fencing is erected to municipal requirements.

Excavation for foundations and placing of concrete then proceeds. After completion of the foundations, the steel supporting structures and buildings are erected. Erection of the electrical equipment then begins: Most electrical power equipment is brought to the site by conventional road transport. The large power transformers are moved to the site using heavy load transportation equipment under the supervision of Ontario Hydro and local road authorities. In some instances, transformers can be moved directly to the site using rail facilities where these are available or have been provided. Landscaping is carried out during and after construction as site constraints and seasons permit.

#### **4.2.7 Operation/Maintenance**

In most cases, transformer stations of the type covered by Class EA are unattended and are operated remotely from a district control centre. A travelling operator makes periodic inspections and can be dispatched to the station in the case of an emergency. In stations where attendance is required, working facilities are provided within the control, meter and relay area.

Whenever preventative or emergency maintenance is required, a work crew is dispatched to the site.

### **4.3 Distributing Stations**

#### **4.3.1 General**

Ontario Hydro maintains a network of sub-transmission/distribution lines and distributing stations to provide electrical service to the rural distribution electricity systems. There are about 800 distributing stations province-wide, less than 10 per cent of these stations are supplied at 115 kV. The rest are served at voltage levels less than 50 kV.

#### **4.3.2 Basic Design**

There are two basic types of distributing stations generally in use, one which uses lower structures but requires more land (i.e., low-profile) and one in which the structures are higher but less land is required. Most new 115 kV distributing stations are of the low-profile open-type structural steel

design (see Figure 2-3). In a low-profile station, the switching structures and power transformers are usually contained in an area approximately 40 m by 35 m (less than 0.15 ha). The station is enclosed with a 2.4 m high chain link fence and typically is situated in the middle of a parcel of land having a total area of 0.80 ha. The land between the station chain link fence and the property lines is used for grading, drainage, landscaping and sound attenuation purposes. The front, side and rear lot setbacks meet or exceed municipal requirements. A 3.5 m wide driveway is required to access the station for operating and maintenance purposes.

The distributing stations are unattended and do not require water or sewage connections to municipal systems.

Provisions are made in the station design to limit or contain transformer oil spills so that no adverse effects are suffered by the surrounding environment.

The electrical equipment contained in the distributing station is designed to prevent radio and TV interference.

The sound from the power transformers is within municipal standards and complies with the Ontario Hydro Protocol for Community Noise Control.

All municipal bylaws, regulations and codes are adhered to in the construction of the distributing stations. Land severances are approved through County Land Divisions or Municipal Committees of Adjustments. Building, land use and road service entrance permits are applied for and received before any field construction work is commenced.

### **4.4 Telecommunication Towers**

#### **4.4.1 General**

Ontario Hydro maintains an extensive telecommunication network. This network allows continuous surveillance over major transmission facilities, and in the event of a malfunction on the system, it enables protective relay operation to automatically isolate the faulted system component. It also gives Ontario Hydro operators continuous information on the status of major lines and stations under their control and provides communications for maintenance activities.

#### **4.4.2 Basic Design**

Telecommunication towers are normally constructed of structural steel members and may be either self-supporting or guyed. Guyed towers may be used where land procurement or power station restrictions are not a problem. The height of the tower depends on the elevation of the site and the terrain that the radio signal must cross.

Usually, the only installation required in addition to the tower is a small and specially designed building for the associated equipment. Site improvement, including landscaping, is undertaken as necessary at each site. Setback and severance is in accordance with Ontario and municipal regulations. An access road to the radio site is also necessary if the tower is not located on a station site, but generally a parcel of land

measuring 30 m by 30 m is sufficient. Most Ontario Hydro telecommunication towers are located on or adjacent to transformer station sites.

#### 4.5 Decommissioning

When transmission facilities become obsolete or unserviceable, the equipment is retired from service. The facilities may be removed and the site made suitable for some other purpose. When transmission structures are removed from farm land, the foundations are cut back 0.5 m below groundline in order to eliminate any obstruction to farming operations.

The disposition of rights-of-way and station sites would be in accordance with Section 3.9, "Land Surplus to Ontario Hydro needs".

Treatment of abandoned station or tower sites will be in accordance with Environmental Guidelines for Construction and Maintenance of Transmission Facilities. In addition, if a station site is suspected to be environmentally contaminated, the decommissioning of facilities will follow Ministry of the Environment guidelines for the "Decommissioning and Clean-up of Sites in Ontario".

#### 4.6 Land Surplus to Ontario Hydro's Needs

Any land acquired which is surplus to the needs of Ontario Hydro may be disposed of by sale. Ontario Hydro offers such land to former owners, adjacent owners, public utilities, government and government agencies prior to offering it to the general public. Sales to the general public will vary depending on circumstances and may be through public tender, real estate broker, auction or direct sale. In the event a severance is required, prior to the sale of such lands, Ontario Hydro will consult with affected municipalities pursuant to an operational policy covering the subdivision of lands under the Planning Act.

In the event the surplus land is not sold, Ontario Hydro will continue its normal land management responsibilities.

#### 4.7 Electric and Magnetic Fields (EMF)

Electric and magnetic fields are invisible lines of force produced by the flow of electricity in a wire or electrical device. The strength of these fields rapidly weakens from their source.

Electrical field strengths at the edge of Ontario Hydro's high voltage transmission line rights-of-way usually do not exceed 1 kV/m (kilovolts per metre). The lines are designed so that the field strength never exceeds 3 kV/m. The magnetic field strength at the edge of the high voltage transmission line right-of-way is generally less than 5 ET (microtesla). Ontario Hydro's booklet entitled *Electric and Magnetic Fields*, explains these fields and gives typical EMF values for transmission facilities, as well as typical values around the home and workplace. This booklet is available to the public.

Upon request, the following is available to anyone wanting more information on EMF in general or interested in EMF levels at specific locations:

- Information on the EMF issue prepared by Ontario Hydro as well as from independent government authorities.
- Access to the Ontario Hydro public reference library of EMF material.
- Presentations to community groups, municipal councils, etc., by Ontario Hydro staff knowledgeable about EMF.
- EMF mathematical calculations and field measurement at specific locations using hand-held meters.

A toll-free telephone number is provided for EMF enquiries (1-800-263-9000). To ensure information is made available to the public is as up to date as possible, Ontario Hydro will remain abreast of developments on the subject worldwide and will continue to support research on an international level. More information on EMF is given in Appendix K.

## Appendix A

### Ontario Hydro Regions and Areas

---

Ontario Hydro has divided the province into five administrative regions which are responsible for the day-to-day operation, maintenance, land and property management activities related to the distribution and bulk electricity systems (see Figure A-1).

Hydraulic generation, transmission and transformation facilities are operated and maintained by regional personnel to generate and transmit bulk power to distribution points. Distribution facilities are constructed, operated and maintained, and power is marketed and delivered to the various types of customers within each region. Customers vary from individual residences to heavy industrial users, each of which has its own specific requirements and demands for electricity. Properties are managed to derive maximum financial benefits for the corporation, and maintenance is carried out on rights-of-

way and other properties to ensure reliability of service, to protect the environment and enhance corporate relations with the public and government. Regional personnel are also responsible for the enforcement of regulatory functions assigned to Ontario Hydro. Functional guidance for these activities is provided by head office divisions.

In order to make staff more responsive to the needs of the customer, each of the regions is subdivided into areas and districts which vary in size and number according to the geography of the individual region. The offices and service facilities serving the individual areas and districts are at convenient locations within their respective areas. Each is responsible for forestry, lines and customer relations activities associated with the distribution of electricity to the customers within its jurisdiction.

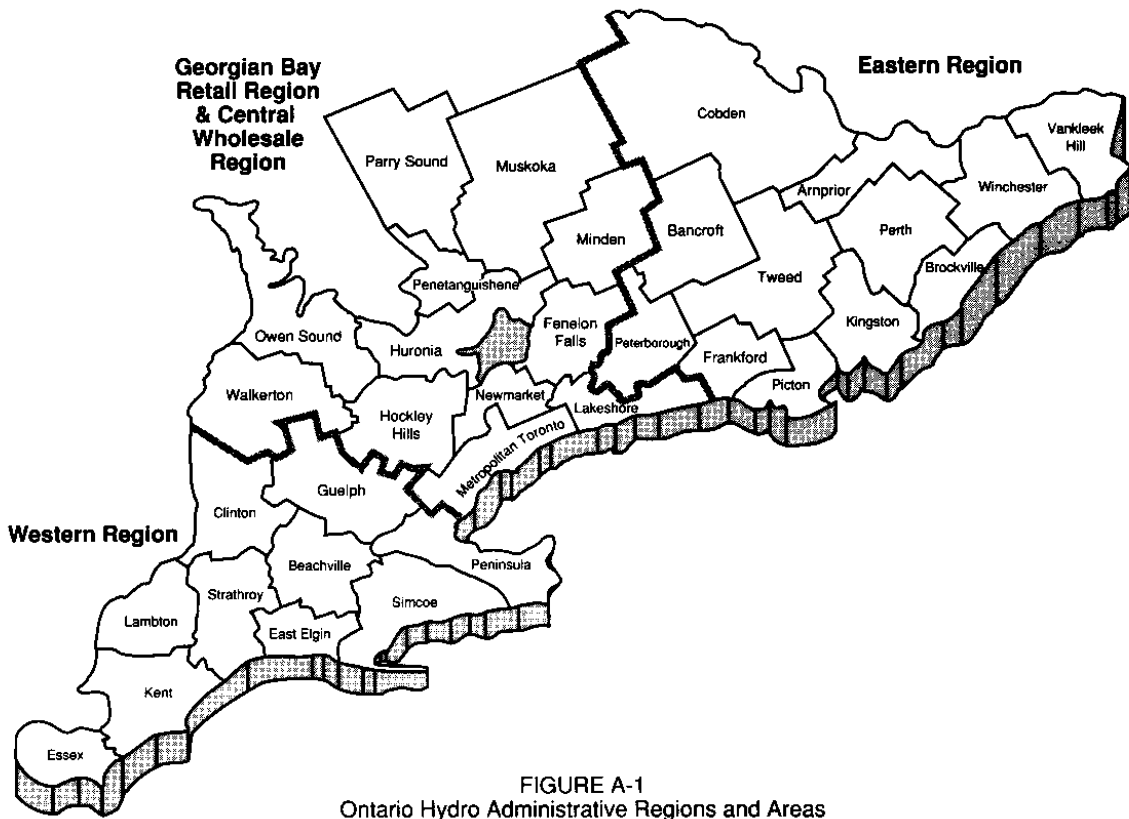
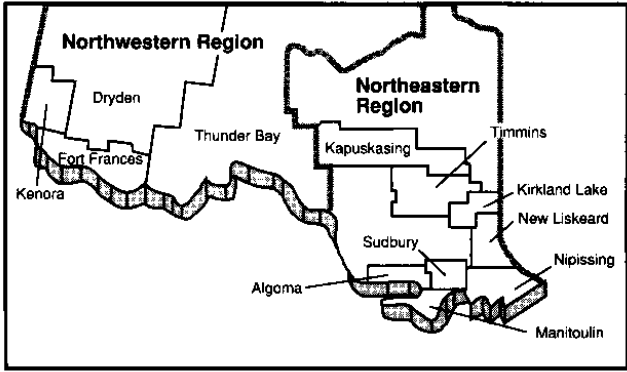

FIGURE A-1  
Ontario Hydro Administrative Regions and Areas

## Appendix B

### Load Forecasting Considerations and Methods

---

#### The Process of Growth

Much of the growth in electrical demand in the last 20 years has come from space conditioning. As a result, demand has become much more sensitive to temperature, and relatively less sensitive to daylight. To a great degree, the advent of windowless space has made lighting demand independent of natural daylight.

Weather fluctuations and economic fluctuations are quite different in their impact on the system. While both are random and unpredictable, the duration of fluctuations due to weather is short; that of economic fluctuation is prolonged over a matter of years. In medium-range forecasting appropriate to Ontario Hydro's decision lead times, it is therefore much easier to deal with weather fluctuations than it is to cope with the business cycle. For one thing, it is relatively easy to define expected or normal weather conditions, and extremely difficult to do the same thing for economic conditions, because climate or average weather can safely be assumed to be stable.

The economic climate, or normal economic state is subject to change over time with inventions, wars, depressions and changes in population, lifestyles, incomes and prices. In other words, there are structural changes going on in society which profoundly affect the demand for electric energy over the long run—events such as sustained rates of immigration, birth rates, the urbanization of Ontario, the shift from single-family dwelling units to apartments, and the growth of tertiary industry. More recently there has been a growing concern with the environment and the quality of life. The impact of this concern on the demand for electric energy gives rise to considerable focus on growth in energy consumption in general and electric energy consumption in particular as evils to be avoided.

At the same time, the importance attached to the quality of the individual's personal indoor environment has led to a growth in air conditioning and electric heating. Insofar as cleaning up the atmosphere and the provincial waterways is concerned, industries and municipalities can comply by introducing electrically powered equipment for recycling and removing materials from their effluents.

Electricity differs from most other forms of energy in that it is a manufactured product which can be made from almost any other type of energy. Consequently, it is able to draw on more technical alternatives than any other energy source, and this may tend to make its price more stable over the longer run. However, electricity supply is a very capital-intensive industry, so that fixed costs tend to rise in the presence of unforeseen low demand. This in turn puts pressure on unit costs, thence prices and back to demand. The spiral works in both directions.

Generally, the demand for electric energy has grown more rapidly in its mature phase than other types of energy. Electricity has therefore acquired an increasing share of the energy market in Ontario with the passage of time. The

dramatic change since 1977 has been the drop in growth of per capita usage—reflecting increased real electricity prices and stagnant per capita real income. The prospects for the future seen from this perspective in time, calls for a moderation in the rate of population growth (depending on fertility rates, net migration to Ontario from other provinces and Canadian immigration policy). While subject to considerable uncertainty, the prospects for the shift seem to be further towards electricity, depending on relative prices and availability of other fuels, the availability of capital and the thrust of public environmental policy and conservation efforts. At the same time, the thrust of research and development in all of the energy industries has shifted from finding new uses towards developing equipment which minimizes energy use because of its high cost.

The effects of price and incomes on the growth of demand for electric energy are extremely difficult to assess. In the industrial sector, the technical coefficients (units of electrical energy input per unit of output) do not seem to be especially stable within an industry and, of course, they vary considerably between industries. The prospects are that this approach will prove even less rewarding in the future than in the past due to the pollution abatement than to production. The commercial sector, which is growing most rapidly, has undergone considerable change in its nature of use of electricity, and there is uncertainty as to the future pattern of use.

Because residential consumption is relatively homogeneous (in comparison with industrial and commercial), it leads itself, to a greater degree, to statistical analysis.

What has been observed in that residential consumption is very responsive to incomes. This shows up very clearly in the behaviour of municipal residential consumption since World War II. There has been a remarkable stability in the relationship: monthly energy consumption is approximately the amount that can be purchased with the earnings from three hours of work. During the period, appliance prices and rate structures have remained relatively stable, but incomes have risen substantially. With the increasing number of households with both husbands and wife working, income per residential customer has been well maintained.

Much more difficult to estimate is the response of consumption to price. Part of the difficulty stems from the residential block rate which makes average price depend on consumption. This makes it impossible to observe the effect of price on consumption directly. In general, it is not possible to observe anything more than a series of points in different price-quantity relationships. However, in cases where there have been abrupt changes in rate level, it may be possible to estimate what consumption would have been in the absence of the rate change, and hence to estimate the effect of price on consumption. From this, crude estimates of price elasticity can be made. Studies to date indicate that price elasticity is also a function of time.

A customer's consumption of electricity by use of the



particular stock of appliances that he owns probably does not respond immediately to any change in the price of electricity. However, a customer may greatly increase his stock of appliances and his use of electricity, if there is a significant reduction in the price of electricity.

In the case of price increase, customers probably have to suffer a loss in order to dispose of or forego the use of appliances. In some cases (e.g., rental water heaters) where competitive forces permit an easy substitution without the customer suffering a capital loss, the adjustment can be quite drastic and rapid. In other applications, such as electric heating, the consumer has less freedom of choice, but nevertheless the impact on new business can be significant. In the long run, the relevant price in each application is the price relevant to competitive services.

This is an important area in which ignorance of the process persists. With the prospect of increases in all energy prices, but with variable timing of the impacts on different fuels, the near-term (next decade) uncertainty is quite large. The long-term outlook for the relative price of electricity is that it may tend to become more attractive if only because of the large number of technical options open in the process of its manufacture.

While government policy may have little impact on the magnitude of total growth in Ontario, it is expected that it may have a considerable impact on the geographical distribution of that growth. This will depend on the degree to which market forces are overcome or redirected by that government policy. While there is almost complete agreement with this premise, there is no such unanimity on any particular alternative to it, and consequently the details must evolve through the political process. This complicates the forecasting problem in that political forces must be taken into account. It is necessary to forecast the outcome of the process which may prove to be quite different from the intent. This may pose problems in forecasting and will require at least that some additional provision for uncertainty be made in these forecasts on this account,

### **The Forecasting Process – General**

The process of growth described in the previous section consists of inferences drawn from observation and study of growth in the demand for electricity in Ontario and elsewhere over many years. The description is an effort to relate the growth process in a general way to the wider economy and the society in which it operates. Such a description has explanatory merits, but it often lacks the precise quantitative relationships which are required for it to have merit for prediction. For one thing, a forecasting approach based on explanatory social and economic variables requires not only a reliable forecast of those variables, but a means of translating them precisely into electrical demand in Ontario. Moreover, the planning and decision requirements call for the geographical distribution of electrical load in Ontario as well as the time path of system demands. For these reasons, the forecasting approach in Ontario consists essentially of forecasts of individual customers' peak and energy loads which are accumulated into totals which are then translated into peak and energy demands by introducing estimates of diversity and/or losses. In some cases it may be necessary

for loads to be forecast for customers who may not now exist. Unallocated load is used for this purpose.

Unallocated load can also be used to reduce the forecast in circumstances where judgement assisted by the results of forecasting models indicates that total estimates for a class of customers are too high, or too low while it may not be possible to isolate which particular forecast is wrong. For example, the total forecast for a group of paper companies may be unreasonable, but in the absence of a detailed assessment of the competitive position of each company, it is not possible to modify individual forecasts.

With the increase of decision lead times, a need for longer range forecasts has arisen. For these forecasts, mathematical models are essential. They serve only to narrow the range of uncertainty by a small amount. There are too many uncertainties to be captured by the most sophisticated model and they multiply as the forecast horizon and decision lead times are extended.

The load forecasting system in Ontario Hydro for the short-to-medium terms consists of mathematical models and the application of the detailed knowledge of individual customers which is available from Ontario Hydro personnel in the field, within utilities and areas, and from direct customers served by Ontario Hydro. The reasons for adopting this detailed approach over that of deduction from global, social and economic causes are twofold:

- (a) It appears to produce aggregate or system forecast of greater accuracy than any deductive mathematical model which has been applied to date.
- (b) It produces the needed geographical details of customer peak demands which is needed for planning purposes, while a model using explanatory social or economic variable would tend to yield annual energy, perhaps by end-use category, which would then require disaggregation into monthly energy by geographical unit and translation into peak load.

The fact that this approach produces short-to-medium range forecasts with smaller errors than other methods is not altogether surprising when one considers that it brings to bear more relevant information than is the case with even the largest econometric model. As the time horizon extends into the future, the available knowledge becomes less, and consequently greater emphasis tends to be placed on mathematical techniques.

A disadvantage of the system for explaining the forecast, but not in using it for planning purposes, is that changes in explanatory economic and social variables - such as birth and immigration rates, incomes, changing consumer preferences, etc., - are captured by the approach, but they are not isolated by it. For example, increased demand by virtue of concern for the environment may show up in the forecast as a new sewage plant in a municipality and some additional pumps in a paper mill, but this load may or may not be specifically identified by its cause.

Similarly, declining rates will show up in altered plans for housing types and quantity, but once again the cause will not be identified-although it may be speculated on after considering trends in the aggregate forecast. Moreover, the classification system of customer's loads is primarily geographical and administrative rather than by end-use classification, except perhaps for direct industrial load. In any event, even if end-use classifications were available, they would most likely refer to energy on an annual basis, and it would be extremely difficult to convert such predictions to peak load on a monthly basis with the required geographical distribution.

Consequently, the forecasting process as it exists differs from the process of growth as it has been described. Nevertheless, some understanding of the process of growth provides a useful background against which to assess the results of the forecasting process in an attempt to answer the vital final question: Are the results reasonable?

No forecasts carries with it any guarantee of accuracy, and the occasional forecast can be badly in error. In assessing the bad forecasts it is useful to have available for scrutiny a general statement on expectations at the time the forecast was made. A forecast is bad only if a better one could have been made with the information on hand at the time. Anyone can make a good forecast with the benefit of hindsight. Similarly, an assessment of the uncertainties associated with the forecast gives its users some appreciation of the risks that they run and often provides an insight into the cause of subsequent forecast error.

### Short-term Forecasting Models

For several years the Load Forecasts Department has been gaining experience with several more advanced forecast modelling techniques. These use monthly data and comprise single and multiple variable time series methods as well as a regression technique that focuses on modelling patterns in the remaining error terms.

Since January 1988, the Load Forecasts Department has adopted a weather-correction methodology which adjusts for wind speed, illumination and humidity in addition to the temperature effects previously taken into account. This methodology was used to create a historical time-series of monthly weather-corrected data that goes back to 1971. The model estimated by EPRI's *Forecastmaster* software using these data had considerable better fits than in the past.

The single variable time series model, called the Box-Jenkins technique after the original developers, presumes that all the information relevant to predicting the future of a variable is contained within the data history of the series to be predicted. Box-Jenkins models may be expected to forecast well in periods when the factors which affect the variable being forecasted continue their recent trend. For economic data this is unlikely to be longer than about two years and is often considerably less time. Predicted changes to the background environment of the forecasted variable that are out of keeping with recent trends will not be reflected in the projection made by the Box-Jenkins model.

Multivariate time series methods are an elaboration of the

single variable technique which permit key causal variables to be included in the forecasting equation. The form of multivariate time series analysis in *Forecastmaster* which is used by the Load Forecasts Department is still dominated by recent patterns in electricity use; a forecasted change in the trend of GDP growth has noticeably less impact on the forecast than the same change would have in one of the annual econometric models.

The third monthly modelling technique is known as *Auto Pro*. This methodology is a hybrid of standard regression techniques and the time series methods used by the other two model types just described. It is not as responsive to external shocks, such as a marked economic slow down, as the pure econometric techniques used to fit the annual models.

The annual models are single equation econometric models of primary energy sales. A review of these models was conducted early in 1988. These models were evaluated on the basis of goodness-of-fit, ex post forecasting performance and economic properties. All depend heavily on real Ontario GDP.

### The Long-term Basic Load Forecast

The method used to prepare the long-term forecast is evolving to meet Ontario Hydro's changing planning needs. In particular, the emphasis on incentive-driven demand management has significant consequences for the effort placed on development of detailed end-use modelling systems. The Basic Load Forecast is a projection of the load Ontario Hydro expects to serve under market conditions where there are no interventions by Ontario Hydro in the form of incentives. For the purpose of this forecast, long-standing Hydro activities such as research, education and promotion, which transfer information (but not money), are assumed to be part of the normal operation of the marketplace.

The Primary Load Forecast is derived from the basic by netting out the impact of financial incentive-driven demand management and load displacement generation programs.

In general terms, two approaches are taken to estimating electricity demand in Ontario: 'top-down' econometric modelling and 'bottom-up' end-use modelling. Both attempt to capture the effect of a large number of demographic, economic, energy market and technological factors on electricity demand in the long run. Because they do so at different levels of aggregation, the techniques available for extrapolation into the future differ. The strengths and weaknesses of these models are reconciled judgmentally in order to arrive at a recommended forecast for planning purposes.

The econometric approach relies on statistical analysis of past energy consuming behaviour and forecasts of broad economic aggregates to generate estimates of future electricity requirements. The end-use approach tends to be so specific that historical data sets may not be available for statistical analysis. Instead, expert opinion on key technology or market trends are combined with very detailed forecasts of activity levels in end-use categories to derive the forecast. However, as data quality and detail improve and

estimation techniques become more sophisticated, econometric results may increasingly determine many specific end-use forecasts. The hard distinction that once existed between engineering end-use (or process) models and econometric models is becoming less clear cut. The need for the load forecast to be tied to a broad scenario for the economy and at the same time be sufficiently detailed to be useful for analyzing demand management programs is pushing methodology to a common ground. The result will exploit the best of both worlds.

The econometric forecast of electricity demand in Ontario is produced by EEMO, the Econometric Energy Model for Ontario (the energy module of the former EDEM system). EEMO takes as inputs forecasts of 13 final demand categories for the Ontario economy provided by the Economic Forecasts Section. These are processed by input/output matrices in the course of deriving industrial and commercial sector energy demands. Forecasts of electricity and other fuel prices contribute to projecting electricity's future market shares. The residential sector electricity forecast depends critically on the demographic forecast which is used to derive the economic outlook.

The end-use forecasting model which has been operating for several years at Ontario Hydro serves as a single large

accounting system for residential, commercial and industrial energy use. Forecasts of sub-sector activity levels, fuel market shares, penetrations rates and technology changes must be provided in order for the model to derive end-use electricity demands. The Load Forecasts Department has also been adapting to the Ontario context a set of more sophisticated end-use models developed by the Electric Power Research Institute. The residential model known as REEPS (Residential Energy End-Use Planning System) and the commercial model, called COMMEND, have both been simulated this year in parallel with the existing models. They incorporate econometric equations to produce some of the market share and technology choice results which formerly had to be determined outside the end-use model.

The use of more than one model allows the forecaster to take into account more of the available information about the past in order to assess the future. Any differences between the forecasts are instructive, since they can be traced directly to the model or to the underlying assumptions. This gives the forecaster the ability to ensure consistency and the validity of the final forecast recommended.

# Appendix C

## Accommodating the Official Load Forecast for Individual Detailed Studies

---

### Customer Forecast Disaggregation

When disaggregating a customer forecast into components, it must be decided whether the individual components will have either the same growth rate or different growth rates. In either case, the growth rate of the sum of the components should be approximately the same as indicated in the load forecast report. The only exceptions to this rule would be:

- (a) Where new information, not available when the forecast was being prepared, is to be included in one or more of the component loads, and;
- (b) To study the sensitivity with respect to load growth of the timing of new facilities or of the choice of alternative new facilities, a higher or lower rate than in the forecast is used. Use of such a growth rate would normally be made in addition to and not in place of the official growth rate.

The choice between the same or different component growth rates in each particular case would depend firstly on the geographically homogeneity of the municipality or area. Is one section more developed or growing faster than another section? For example, the southwestern part of the City of Scarborough is nearly fully developed and is growing slowly, whereas the northeastern part is only partly undeveloped, but is now growing quickly. It also depends on the type of development going on in various parts of the customer area. One part may be devoted to single-family or low-rise apartment residential development, another to high-rise commercial and/or residential development, and still another to industrial development. Each of these parts would have its own particular growth due to population increases, per capita increases in consumption, and shifts from one form of energy to another.

The decision as to whether or not component load growths will be considered the same or different can be made by the system planner, but in most cases he will seek the advice of regional, area or municipal utility staff. If it is decided to use different rates for each component, the choice of the rates would be made in one or more of the following ways:

- (a) By the planner using available historical data.  
  
For example, the large utility (or area) may be supplied by several transformer stations or distributing stations. Taking care that all past load transfers between stations are included, historical growth rates on the stations can be taken as the expected growth rate for each part of the utility (or area). This method would require only a minimum of contact with regional and/or utility (or area) personnel.

- (b) By consultation between the planner and the utility (or area) staff.

In this case, the component projections would probably be based on historical data as above, but modified by the intimate knowledge of the local staff to reflect new developments.

- (c) By the municipality utility staff.

In this case, the component forecasts, particularly in the early years, may be based entirely on known building starts, issued building permits, approved subdivision plans and firm enquiries about electrical supplies.

### Combining Customer Forecasts

If more than one system customer, or parts of more than one system customer, are supplied from existing facilities at the anticipated system weak point, or will be supplied from the proposed new remedial facilities, these customer loads and customer load components must be combined for use in the detailed study. A decision must be made as to whether or not these loads might peak at the same time. If they are similar types of load and are geographically close to one another, then they are likely to peak together and it would be adequate simply to add the forecasts together. If they are different types of load, they could peak at different times of the day, i.e., downtown commercial load might peak at 11:30 in the morning, while residential load supplied from the same station may peak at 5:30 in the evening. In combining these loads, a diversity factor (a multiplier less than unity) would have to be used.

If the customers are geographically (and electrically) some distance apart, the supply facility will have to provide for some line losses as well as supply the customer loads. In combining these loads, a loss factor (a multiplier more than unity) would have to be used. Establishment of these diversity and loss factors is the responsibility of the planner in consultation with utility or area personnel. They are usually based on historical data.

### Extending Forecasts

The long term costs associated with each system option are evaluated using the discounted cash flow method. To determine what facilities will be needed over the long term, it is necessary to have a long term load forecast. Such a forecast frequently covers 20 years into the future.

Long term forecasts are prepared annually (see Appendix B). The impacts on costs of higher and lower rates of growth than forecast is normally considered. For a specific transformer station, information may also be obtained from municipal utilities and Ontario Hydro regional and area offices.

**Changing to Apparent Power**

The ratio between the real power and the apparent power supplied to a load (termed the power factor) is usually less

than one and greater than 0.9. Historical data are used in estimating what the future power factor of a particular customer, station or geographical area is likely to be.

# Appendix D

## Inventory of Existing Supply Facilities Checklist

---

### Generation

All existing and planned generation in the area of concern should be included in the inventory. The inventory will include the following steps:

- (a) Identify the location, type and size of each plant.
- (b) Determine the number of units and the normal and emergency ratings and capabilities of each.
- (c) Obtain historical data relevant in forecasting the future performance of the generation facilities, including data concerning forced outages due to equipment failure or human error, and scheduled outages for maintenance.
- (d) Identify possible conflicting requirements in operating the generation facilities from overall system considerations and from purely local considerations.

### Transmission Lines

All existing and planned transmission lines located within or in the vicinity of the area of concern may be of importance in studies for the area and will be included in the inventory using the following steps:

- (a) Identify line route, width of right-of-way and line length.
- (b) Identify types of structures, number of circuits, number and type of insulators per string and type of line hardware.
- (c) Determine the voltage rating of the line.
- (d) Determine the electric current capability (ampacity) of phase conductors.
- (e) Obtain records concerning line performance, including forced outages due to weather, equipment failures and human error, and scheduled outages for maintenance.
- (f) Obtain other pertinent data from design engineers and operating and maintenance staff.

### Terminal Stations and Step-down Transformer Stations

All existing and planned stations located within or in the vicinity of the area of concern may be of importance in studies for the area and will be included in the inventory using the following steps:

- (a) Identify location and property limits.
- (b) Obtain station drawings. (These usually include station bus, line and major equipment connections; transformer and switchgear nameplate data;

connections to metering, control and protection; and other auxiliary equipment.)

- (c) Identify the location, connections, capabilities and ratings of all special station equipment such as synchronous condensers, combustion turbines and generators, reactors and capacitors.
- (d) Obtain records concerning overall station performance and performance of station components, including forced outages due to weather, equipment failures and human error, and scheduled outages for maintenance.
- (e) Obtain other pertinent data from design engineers and operating and maintenance staff.

### Sub-transmission/Distribution

All existing and planned sub-transmission lines and distributing stations located within or in the vicinity of the area of concern may be of importance in supply studies for the area and will be included in the inventory by the following these steps:

#### For lines:

- (a) Identify line route, width of right-of-way and line length.
- (b) Identify types of structures; number of circuits, number, type and composition of phase and ground wires; types of insulators and line hardware.
- (c) Determine the voltage rating of the line.
- (d) Determine the electric current capability (ampacity) of phase conductors.
- (e) Obtain records concerning line performance, including forced outages due to weather, equipment failures and human error, and scheduled outages for maintenance.
- (f) Obtain other pertinent data from design engineers and operating and maintenance staff.

#### For stations:

- (a) Identify location and property limits.
- (b) Obtain station drawings. (These usually include station bus, line and major equipment connections; transformer and switchgear nameplate data; onnections to metering, control and protection; and other auxiliary equipment.)
- (c) Identify the location, connections, capabilities and ratings of all special station equipment such as mobile

or spare transformers, combustion turbines and generators and capacitors.

(d) Obtain records concerning overall station performance and performance of station components,

including forced outages due to weather, equipment failures and human error, and scheduled outages for maintenance.

(e) Obtain other pertinent data from design engineers and operating and maintenance staff.

# Appendix E

## Power System Stability

### Power System Stability

One of the important considerations in the design and operation of a power system is the stability of the system. The term power system stability, as ordinarily used, is applicable only to three-phase ac power systems having synchronous machines which encompass practically all large present-day power systems. It denotes the ability of the synchronous machines to remain in *synchronism* through normal and abnormal system conditions.

A brief discussion of the characteristics of a synchronous generator is useful in the understanding of the various aspects of power system stability. Figure E-1 shows the basic elements of a generating unit consisting of synchronous generator, a turbine and the associated controls. The generator has two sets of windings, one set wound on the stator and the other on the rotor. The rotor winding is excited by the direct current and is referred to as the field winding. The turbine drives the rotor and the magnetic field produced by the rotor winding induces alternating currents in the stator windings which are supplied to the load. The frequency of the ac in the stator depends on the speed of the rotor, i.e., the electric frequency is synchronized with the mechanical speed and this is the reason for the designation of synchronous machine. The field winding is supplied from an exciter which may be a dc generator or a controlled rectifier. The voltage of the exciter is varied by an automatic voltage regulator to control the terminal voltage of the synchronous generator. The exciter and the automatic voltage regulator are part of a control system which is called the excitation system.

When two or more generators are connected in a power system they must operate in synchronism, i.e., at precisely the same average speed. The two generators are in some ways analogous to two cars speeding around a circular track and joined by a strong rubber band. If the two cars run side by side, the rubber band will remain intact. If one car temporarily speeds up with respect to the other car, the rubber band will stretch and tend to slow down the faster car and speed up the slower car. If the pull on the rubber band

exceeds its strength it will break and the one car will pull away from the other car thereby breaking synchronism. The pull on the rubber band is related to by the angular displacement between the two cars.

In the case of two synchronous generators connected in a power system, the power transferred from one generator to the other is a function of rotor angle, and has the characteristic shown in Figure E-2. Under normal operating conditions, the rotor angle is such that no power is transferred from one generator to the other. As the rotor angle increases the power transferred increases until it reaches a maximum value. The magnitude of this maximum power depends on the impedance of the system connecting the generators, being greatest when the impedance is lowest.

Normally, the mechanical output of the turbine closely matches the electrical output of the generator and the speed of the generator remains constant. If a fault occurs close to one of the generators, its voltage drops and its electrical power output is drastically reduced. The mechanical output of the turbine then exceeds the electrical output of the generator and the excess mechanical power causes the rotor to speed up and the rotor angle to increase. When the fault is removed, the greater rotor angle causes power to be transferred from one generator to the other, and if sufficient energy can be transmitted between generators, the generators will remain in synchronism. A strong transmission system between the two generators is analogous to a strong rubber band between the two cars.

If the initial disturbance is too severe, or if the transmission cannot carry enough energy to ensure synchronism, then the generator will pull out of step. When the generator pulls out of step, it must be quickly removed from the system or it will cause severe voltage disturbances, may cause other generators to pull out of step and may cause damage to the generator and other equipment.

For convenience in analysis and for gaining useful insight into the nature of the stability problem, it is usual to classify power system stability in terms of the following categories.

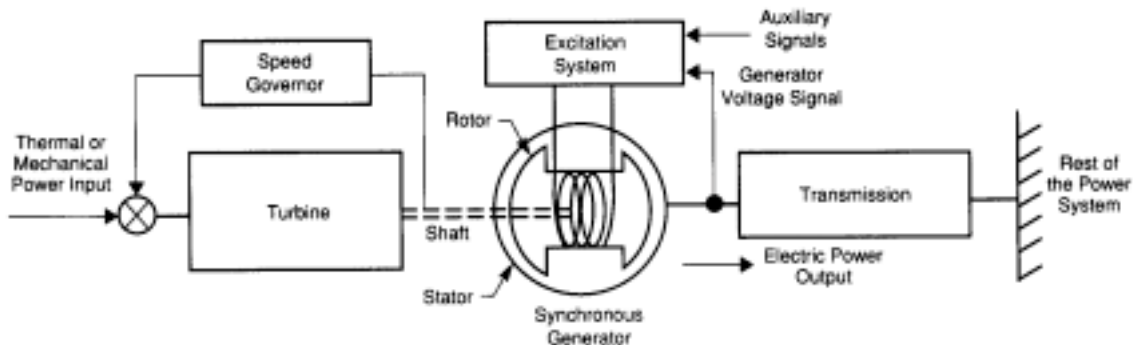

FIGURE E-1  
A Turbine-generator Unit and its Controls



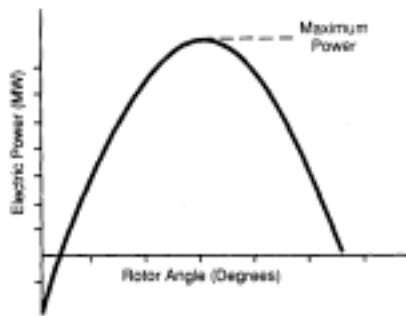

FIGURE E-2  
Power Angle Relationship of a  
Synchronous Generator

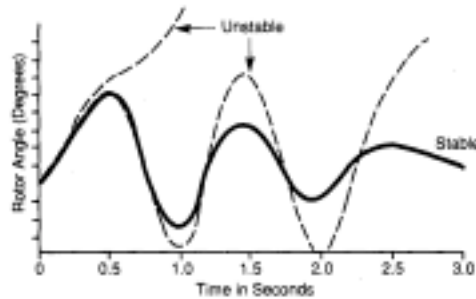

FIGURE E-3  
Nature and Behaviour of a Synchronous Machine  
for Stable and Unstable Situations

### Transient Stability

Transient stability is concerned with the response of the system to a large disturbance such as a fault on the transmission system. Transient stability is normally concerned with the behaviour of the system up to about 5 s following the disturbance.

The nature of the behaviour of a synchronous machine for stable and unstable situations is illustrated in Figure E-3. The figure shows the rotor angle following a sudden disturbance for a stable situation and for two unstable situations. In the stable case, the rotor angle increases to a maximum, then decreases and oscillates with decreasing amplitude until it reaches a steady state. In the unstable cases, the rotor angle continues to increase until synchronism is lost or it continues to oscillate with increasing amplitude until it loses synchronism in one of the subsequent swings.

### Small Disturbances Stability

Small disturbance stability is concerned with the response of the system to small disturbances which continually occur in the operation of a system. This response is very dependent on the characteristics of the excitation system used. The use of supplementary stabilizing signals in the excitation system provides a means of improving small disturbance stability. In fact, for most system arrange-

ments it is possible to design and install an excitation system which will completely eliminate small disturbance stability problems. Ontario Hydro uses an excitation control scheme with the stabilizing signal derived from turbine-generator shaft speed. Initially, the scheme was developed for hydraulic units and was later applied to thermal units also. The possibility of exciting torsional oscillations of the turbine generator shaft system had to be eliminated before the scheme could be applied to thermal units. This type of excitation control is now a standard feature for all new generating units.

### Stability Limit

The power system stability problem is one of keeping the interconnected synchronous machines in synchronism. Since it is the network that provides for power flow between generators and loads and between different generators, the strength of the transmission network is the primary factor in influencing stability. However, the characteristics of the generating units and the associated controls also have significant effects on stability. For any given system, there is a maximum amount of power that can be transferred from one part of the system to another due to stability considerations. The critical value of power above which the system is unstable and below which it is stable for specified disturbances is called the stability limit.

# Appendix F

## Computer Programs Used in System Analysis

---

### Load Flow Program

Load flow programs are the most frequently used programs for system studies. The basic input comprises the electrical connections, generator, transformer and transmission circuit electrical characteristics; the power and reactive power to be supplied at each load point; and the generator power output and voltage.

The load flow can show the expected power and reactive power flow in thousands of circuits and transformers and the voltage at thousands of system supply points.

The largest programs used by Ontario Hydro can solve a power system with up to 12,000 station buses and 30,000 interconnecting circuits. Computer running time on a large high-speed computer for a large power system is about 5 to 10 min. Other programs for smaller systems are also available.

### Transient Stability Program

For one load flow it may be necessary to perform many transient stability runs for different types of faults and different fault locations.

A transient stability program is considerably more complex than a load flow program because it must solve the dynamic equations associated with acceleration and deceleration of the generator-turbine rotating masses, the energy storage in the magnetic fields and with the excitation and governor control systems. This is in addition to carrying out a series of load flow analyses separated by discrete time intervals of say, 0.01 s, to determine the power flows and voltages existing in the network as the generator angles swing relative to each other. Transient stability analysis normally examine the first 5 s of system time following a disturbance, requiring hundreds of load flow analyses. The computer running time varies from 30 min to several hours.

The program provides the time variation of many quantities such as:

- (a) Generator rotor angles
- (b) Generator power
- (c) Bus voltages
- (d) Circuit power flows
- (e) Excitation system voltage
- (f) Turbine power

The program can also monitor power swings on specified circuits, comparing these with the protective relaying characteristics of the circuit. If a power swing enters the protective zone of the line relays, the program alarms the relay operation in the output data.

### Small Disturbance Dynamic Stability Program

This is a program used to determine the stability of a multi-machine power system for small disturbances. The program is used for the following purposes:

- (a) To determine the dynamic stability limit of power systems under different operating conditions.
- (b) To evaluate the effect of machine, transmission system and excitation system parameters on small disturbance stability.

### Short-Circuit Program

Programs are available to calculate short-circuit currents and voltages as required for the design of protective and other equipment.

### Switching Surge Program

Ontario Hydro's switching surge program represents up to 750 buses and up to 900 elements. Between 55 and 100 generating sources may also be represented depending on whether the system is being studied on a three-phase or single-phase basis.

One version of the program is capable of representing the closing of a three-phase circuit breaker (or switch) with various distributions of closing time and sequence in each of the three-phases relative to a target or ideal closing sequence. The programs will automatically examine 100 cases of various closing times and will provide probability curves of the highest voltages expected. It will repeat the worst or highest case with complete results, including automatic plots of the voltage time curves.

### Transformer Aging Program

Based on test data and insulation aging characteristics of transformers, the temperature at the hottest spots in the transformer windings can be determined for various assumed overloads. The resultant aging of the insulation can also be calculated with reasonable accuracy. Such knowledge enables rational decisions to be made about the timing of transformer replacements and new transformer installations.

## Appendix G

### Environmental Inventory

---

The following is a listing of the environmental factors or categories considered by Ontario Hydro when carrying out an environmental inventory for a route or site planning study. Accompanying each of the factors are examples of typical environmental data types and their sources.

#### HUMAN SETTLEMENT

##### Description

This factor considers the predominantly man-modified environment, characterized by an extensive use, a high degree of human activity and extensive improvements.

##### Typical Data Types:

- (a) Urban Settlement (e.g. cities, town, villages).
- (b) Rural residential development.
- (c) Seasonal development.
- (d) Institutions.
- (e) Military areas.
- (f) Industrial development.
- (g) Commercial development.
- (h) Airports and airstrips.
- (i) Telecommunication towers.
- (j) Environmental contamination areas.

##### Typical Data Sources:

- (a) Existing Land Use
  - (1) Topographical maps.
  - (2) Aerial photography.
  - (3) Ministries of:
    - Transportation.
    - The Environment.
    - Agriculture and Food.
    - Natural Resources.
    - Colleges and Universities.
    - Government Services.
    - Consumer and Commercial Relations.
  - (4) Conservation Authorities.
  - (5) Transport Canada.
  - (6) Parks Canada.
  - (7) Department of National Defence.
  - (8) Field Inspection.
  - (9) Upper and Lower Tier Municipal Departments and Planning Boards.
- (b) Proposed Land Use
  - (1) Ministries of:
    - Municipal Affairs.
    - Natural Resources

- (2) Conservation Authorities.
- (3) Parks Canada.
- (4) Upper and Lower Tier Municipal Departments and Planning Boards.

#### AGRICULTURE

##### Description

This factor considers agricultural production and associated practices through analysis of the potential of the land to produce agricultural products along with the present use and productivity of that land.

##### Typical Data Types:

- (a) Areas of significant fruit, vegetable and tobacco production.
- (b) Prime agricultural soils with a high concentration of common field crops.
- (c) Prime agricultural soils with a moderate concentration of common field crops.
- (d) Prime agricultural soils with a low concentration of common field crops.
- (e) Restricted agriculture characterized by irregular field size and poor quality soils.

##### Typical Data Sources:

- (a) Soil Capability for Agriculture, Canada Land Inventory (CLI), Agriculture Canada.
- (b) Hoffman Assessment of Soil Productivity for Agriculture - A.R.D.A.
- (c) Census of Agriculture, Statistics Canada
- (d) Ministry of Agriculture and Food.
- (e) Ontario Institute of Pedology
- (f) Topographical Maps.
- (g) Air photo interpretation.
- (h) Field Inspection.
- (i) Agriculture Associations (e.g. Ontario Federation of Agriculture and Christian Farmers).

#### FOREST RESOURCES

##### Description

This factor considers the resource use aspects of forest cover, both from the point of view of the use of existing forests and



the capability to produce renewable forest resources.

**Typical Data Types:**

- (a) Forestry land with the Ontario Land Inventory (OLI) Timber Use Capability of Classes 1, 2 and 3.
- (b) Forested land with the OLI Timber Use Capability of Classes 4 or 5, currently supporting mature or immature valuable species, e.g., hard maple.
- (c) Forested land with the OLI Timber Use Capability of Classes 4 or 5, currently supporting mature and immature species of less value, e.g., white ash.
- (d) Forested land with the OLI Timber Use Capability of Classes 4 or 5, currently supporting mature or immature species or poor value, e.g., aspen, unmerchantable species and cut over of burned lands.

**Typical Data Sources:**

- (a) Timber Use Capability; Ontario Land Inventory; Ministry of Natural Resources.
- (b) Forest Resource Inventory; Ministry of Natural Resources.
- (c) Conservation Authorities.
- (d) Air photo interpretation.
- (e) Topographic Maps.
- (f) Field Inspection.

**MINERAL RESOURCES**

**Description**

This factor considers the mineral extraction industry through analysis of existing and planned extractive operations and potential reserves.

**Typical Data Types:**

- (a) Existing and proposed surface and subsurface extractions of metallic/nonmetallic minerals and structural materials.
- (b) Potential aggregate from sand and gravel deposits within a critical distance of identified demand centres.
- (c) Oil and gas deposits.
- (d) Potential aggregate and potential structural materials from sources such as bedrock.

**Typical Data Sources:**

- (a) Ministries of:
  - (1) Natural Resources.
  - (2) Transportation.
  - (3) Northern Development and Mines, e.g.,
    - Ontario Geological Survey
    - Mining Recorders
    - Resident Geologists

- (b) Topographic maps.
- (c) Field inspection.
- (d) Air photo interpretation.

**RECREATION RESOURCES**

**Description**

This factor considers existing forms of recreation (i.e., parks, cottages, major waterways, etc.) along with extensive recreational activities (i.e., canoeing, hiking). Future recreational potential is also considered.

**Typical Data Types:**

- (a) Federal and provincial parks, park reserves and candidate parks.
- (b) Sensitive recreational waterways.
- (c) Sensitive linear areas, e.g., canoe routes, hiking trails, scenic roads.
- (d) Conservation Authority lands.
- (e) Areas of cottage and resort developments.
- (f) Areas identified as recreational in the Canada Land Inventory.

**Typical Data Sources:**

- (a) Ministries of:
  - (1) Natural Resources.
  - (2) Transportation.
  - (3) Tourism and Recreation.
- (b) Conservation Authorities.
- (c) Parks Canada.
- (d) Outdoor Recreation Capability-Canada Land Inventory
- (e) Topographic maps.
- (f) Field inspection.
- (g) Air photo interpretation.

**APPEARANCE OF THE LANDSCAPE**

**Description**

This factor considers the physical appearances of different landscapes and their susceptibility to change due to the imposition of transmission facilities.

**Typical Data Types:**

- (a) Escarpments and mountains.
- (b) Crests.
- (c) Vistas.
- (d) Landscapes visually dominated by water.

- (e) Flat to gently rolling landscapes with little tree cover.
- (f) Remnant natural landscapes and natural river valleys.

**Typical Data Sources:**

- (a) Topographical maps.
- (b) Air photo interpretation.
- (c) Field interpretation.

**BIOLOGICAL RESOURCES**

**Description**

This factor considers areas of biological sensitivity: floral and faunal components of the terrestrial concentration area, designated environmentally sensitive areas, spawning areas, wetlands.

**Typical Data Types**

- (a) Deer yards.
- (b) Moose yards.
- (c) Wildlife management areas.
- (d) Endangered species habitat.
- (e) Swamps, bogs, marshes.
- (f) Rare and unusual faunal habitat.
- (g) Environmental protection area.
- (h) Waterfowl staging and nesting areas.
- (i) Heronries.
- (j) Cold water fish communities.
- (k) Warm water fish communities.

**Typical Data Sources:**

- (a) Ministry of Natural Resources:
  - (1) Surveys, Mapping and Remote Sensing
  - (2) Fisheries Branch
  - (3) Wildlife Branch
  - (4) Provincial Parks and Recreational Areas Branch
  - (5) Regional and District Offices
- (b) Canadian Wildlife Service.
- (c) National Museum of Natural Sciences.

- (d) Conservation Authorities.
- (e) Field Naturalists Associations.
- (f) Atlas of Rare Vascular Plants of Ontario.
- (g) Amateur Biologists and Botanists.
- (h) Air photo interpretation.
- (i) Topographic maps.
- (j) Field inspection.

**HERITAGE RESOURCES**

**Description**

This factor considers the cultural landscape, including the built-up environment with historical significance and archaeological resources.

**Typical Data Types:**

- (a) Designated historical sites, e.g., buildings and plaques
- (b) Buildings of historical architecture, e.g. churches, houses, mills.
- (c) Settlement patterns, e.g. survey fabric, fence rows etc.
- (d) Known archaeological sites.
- (e) Areas of archaeological potential.

**Typical Data Sources:**

- (a) Ministry of Culture and Communications.
  - (1) Regional Archaeologists.
  - (2) Historical Planning Board.
- (b) Parks Canada.
- (c) Upper and Lower Tier Municipalities.
- (d) Historical county atlases of Ontario.
- (e) Archaeological Consultants.
- (f) Survey plans of Ontario townships.
- (g) Local historical associations.
- (h) Local published and unpublished histories.
- (i) Air photo interpretation.
- (j) Field inspection

## Appendix H

### Initial Notification requirements

The following are the notification requirements which have been agreed to by Ontario Hydro and the Provincial Ministries as of December 1989. The listing will be updated as needed.

**TABLE H-1**  
**Initial Notification Requirements for Provincial Ministries**  
**“Class EA For Minor Transmission Facilities” Projects**

Ministry	Notification Requirements	Additional Comments
<b>Primary Group</b>		
1. Environment	Mandatory- all projects	
2. Energy	Mandatory - all projects	
3. Transportation	Mandatory - all projects	Notify Regional Manager Engineering and right-of-way office, who will advise if further involvement is desired. Copy to the Manager, Environmental Office.
4. Natural Resources	Mandatory - type A Selective - type B and C	Notify of type B&C projects if onto new property or MNR concerns affected. Smaller projects also notify district/regional offices.
5. Culture and Communications	Mandatory - type A Selective - type B and C	Notify of type B&C projects if new land archaeological or other man-made heritage features affected.
6. Northern Development	Mandatory - type A	Only concerned about projects north of Parry Sound and Algonquin Park.
7. Tourism and Recreation	Mandatory - type A Selective - type B and C	Notify of types B&C projects if ministry lands, facilities, commercial tourist facilities and attractions or interests are affected.
8. Housing	Mandatory - type A Selective - type B and C	Notify if parkway belt west or ministry lands affected.
<b>Secondary Group</b>		
9. Municipal Affairs	Selective - all projects	Notify if parkway belt lands or an unorganized territory involved.
10. Agriculture and Food	Selective - all projects	Notify only if classes 1-4 or lands in agricultural use are affected.
11. Education	Selective - all projects	Notify only if project is in close proximity to school board properties. Also inform relevant school board.

**TABLE H-1 (Continued)**  
**Initial Notification Requirements for Provincial Ministries**  
**“Class EA For Minor Transmission Facilities” Projects**

Ministry	Notification Requirements	Additional Comments
<b>Secondary Group (continued)</b>		
12. Health	Selective - all projects	Notify only if ministry lands, facilities or interests affected.
13. Government Services	Selective - all projects	Notify only ministry property affected.
14. Community and Social Services	Selective - all projects	Notify Regional Director if ministry land, interests facilities affected.
15. Attorney General	Selective - all projects	Notify only if ministry lands or Native communities are affected.
16. Correctional Services	Selective - all projects	Notify only if MCS operated institutions potentially affected.
17. Colleges and Universities	Selective - all projects	Notify affected institutions only.
18. Solicitor General - Office of Fire Marshal	Selective - all projects	Notify only if emergency services affected.
19. Citizenship	Selective - all projects	Notify only if Native communities affected.
20. Industry, Trade & Technology	Selective - type A Nil - types B and C	Notify of type A projects only if industry or trade negatively affected.
21. Intergovernmental Affairs	Nil - all projects	Require no Class EA project notification.
22. Consumer and Commercial	Nil - all projects	No initial notification required on any Class EA.
23. Labour	Nil - all projects	No initial notification required conjunction with the EA Act.
24. Revenue	Nil - all projects	Do not advise on any projects in conjunction with the EA Act.
25. Treasury and Economics	Nil - all projects	Require no Class EA project notifications.
26. Niagara Escarpment Commission	Selective - all projects	Notify only if lands within the approved plan are potentially affected.

**Notes:**  
**type A**

The planning of, the acquisition of property for, and the design and construction of minor transmission lines and/or transformer station and/or distributing stations and/or telecommunication towers and the subsequent operation, maintenance and retirement of these facilities.

Minor transmission lines include all transmission line projects involving more than 2 km of line which:

- (a) Are capable of operating at a nominal voltage level no higher than 115 kV.
- (b) Are capable of operating at a nominal voltage level higher than 115 kV and which involve less than 50 km of line.



Transformer stations include those stations whose nominal operating voltage is not less than 115 kV and not more than 500 kV.

**type B**

The planning, property acquisition, and design and construction required to modify or upgrade a transmission line, and the subsequent operation, maintenance and retirement of the revised line where:

- (a) The work requires replacement of structures and/or changes in the right-of-way.
- (b) The revised line is capable of operating at a nominal voltage level of at least 115 kV.

**type C**

The planning, property acquisition, design and construction required to modify or expand a transformer station and the subsequent operation, maintenance and retirement of the revised station where:

- (a) An extension of the site is necessary.
- (b) The revised station is capable of operating at a nominal voltage level of not less than 115 kV and no more than 500 kV.

## **Appendix I**

### **Subsequent Communication with the Public**

---

At the conclusion of the environmental study, elected and appointed officials will receive copies of the environmental study report filed with MOE. Reports will also be sent to those individuals who have expressed an interest in receiving one.

On projects where a new Order-in-Council under the Power Corporation Act is not required, a letter will be sent to each owner giving the planned construction schedule and the name and telephone number of the designated construction representative. This representative will be available for further discussion during the construction period. The letter may also include other project contacts such as the surveyors, the project engineer, the property agent and the community relations officer.

In cases where an Order-in-Council has been obtained, and there are several property owners involved, an information centre will be held. Property owners will have an opportunity to discuss tower locations, centreline survey, property policies, construction and restoration operation activities.

Following the information centre, or if no information centre is necessary, each property owner will be visited.

Permission will be requested at this time for carrying out surveying, soil testing, property appraisals and woodlot evaluation as required.

Following the permission calls, appraisal work is commenced. Upon completion of the appraisal, a meeting is then arranged with the owner to discuss the offer of compensation.

When property is to be expropriated, a Notice of Application for Approval to Expropriate is delivered to each owner and the expropriation procedures explained. Once an expropriation has been approved, and if the owner has not yet settled, an offer of compensation under Section 25 of the Expropriation Act will be made. If agreement on compensation cannot be reached, after further negotiation the matter may be referred to the Board of Negotiations and/or the Ontario Municipal Board.

During construction, property owners and elected and appointed officials will be kept up-to-date on construction activities by project newsletters.

## Appendix J

### Examples of Typical Mitigation Measures

**TABLE J-1**  
**Example of Typical Mitigation Measures**

<b>Environmental Concerns</b>	<b>Mitigation Measures</b>	<b>Application</b>
<b>WATER QUALITY</b>		
Sedimentation of streams due to erosion from the right-of-way.	-minimize use of slopes adjacent to streams - maintain a cover crop.	During soil testing, selective cutting, construction and maintenance. During restoration following construction and long term maintenance.
Stream bank erosion.	- mechanical erosion control. - retain shrubby stream bank vegetation and selectively cut or prune trees.	In line clearing/maintenance.
	- selective spraying of herbicides. - mechanical erosion control.	During line maintenance. Stream crossings, as required.
Impedance of natural flow of streams /-other surface waters.	- use and maintenance of appropriate stream crossing device.  - use of equalizing culverts in roads in wetlands.  - use of corduroy in wetlands, where available.	At stream crossings during construction and line operation.  During construction and throughout line operation.  Line construction in wetlands.
Ponding or channelization of surface waters due to rutting.	- timing activities to stable ground conditions. - use of gravel roads.	Construction/maintenance on seasonally unstable ground surfaces. New line construction on unstable ground surfaces.
Contamination of surface or ground waters through spills or leaks of toxic substances.	- spill control material and procedures readily available.  - site selection where possible.	At station sites and in general whenever toxic substances are used.  Stations warehousing sites and structures locations.
Sedimentation of streams with pumped soil/bentonite from dewatering operations.	- containment of material when working in the vicinity of water bodies.  - use of sediment traps or settling tanks.  - removal of material from the site.	Dewatering during installation of augured footings.  When necessary during dewatering operation.  Restoration.
Channel disturbance, sediment production at stream crossings.	- installation of an appropriate crossing device.  - use of sediment traps or settling tanks.	During access road construction.  During access road construction.
Increase in water temperature due to vegetation removal at stream crossings.	- retain shrubby stream bank vegetation and selectively cut/prune trees. - selective spraying of herbicides to retain as much vegetation as possible on stream banks.	Line clearing/maintenance.  Line maintenance (vegetation control).
Reduction in water storage capacity due to removal of vegetation or diversion caused by rutting.	- selective removal of vegetation.  - revegetation with compatible shrubs.	In identified source/recharge areas during initial line clearing.  Selection of structure sites and access routes.

**TABLE J-1(Continued)**  
**Examples of Typical Migration Measures**

Environmental Concerns	Mitigation Measures	Application
<p><b>SOILS</b></p> <p>Soil compaction/topsoil-subsoil mixing.</p> <p>Wind/water erosion.</p> <p>Contamination by petro-chemicals.</p>	<ul style="list-style-type: none"> <li>- avoidance of rutting by vehicles.</li> <li>- construction timing.</li> <li>- use of gravel roads.</li> <li>- use of vehicles with low bearing pressure.</li> <li>- stop activities when ground conditions are poor.</li> <li>- avoidance of areas with high erosion potential.</li> <li>- timing activities to the most stable ground conditions.</li> <li>- slope stabilization.</li> <li>- mechanical erosion control.</li> <li>- vegetation erosion control.</li> <li>- recompaction of trenches.</li> <li>- avoid trenching parallel to the fall of a slope.</li> <li>- spill control material and procedures made readily available.</li> <li>- restoration methods investigated.</li> </ul>	<p>Application in generally all phases of construction and maintenance, particularly during line clearing and construction.</p> <p align="center">"</p> <p align="center">"</p> <p align="center">"</p> <p align="center">"</p> <p>Access road location erodible soils, slopes.</p> <p>Access road location erodible soils, slopes. As required. As required.</p> <p>Erodible soils, slopes, as a restoration measure. Installation of counterpoise, underground transmission lines. Counterpoising on steep slopes. At station sites or during the transport of oil containing equipment. As an ongoing process.</p>
<p><b>FISH AND WILDLIFE</b></p> <p>Loss of habitat, breeding and/or food source for terrestrial wildlife due to Vegetation removal.</p> <p>Changes in composition of vegetation as a result of soil disturbance.</p> <p>Removal or burial of stream bottom habitat and increased turbidity due to sedimentation.</p>	<ul style="list-style-type: none"> <li>- environmental mapping to identify sensitive sites.</li> <li>- avoidance of areas containing rare /- endangered species.</li> <li>- the creation of "edge" (may be considered a positive impact).</li> <li>- promotion of wildlife habitat through vegetation control and brush piles</li> <li>- avoid the filling of small wetlands.</li> <li>- construction timing to minimize soil disturbance.</li> <li>- restoration of soils to a stable condition.</li> <li>- minimize erosion from the right-of-way by maintaining a cover crop.</li> <li>- mechanical erosion control.</li> <li>- minimize stream bank erosion by retaining shrubby bank vegetation and selective cutting/pruning of trees near watercourses.</li> <li>- installation of sediment traps when necessary.</li> <li>- containment or filtering of pumped spoil/water near watercourses.</li> </ul>	<p>Prior to the start of construction, line clearing</p> <p>Access road location, selective clearing for new lines.</p> <p>Selective clearing on a right-of-way.</p> <p>Restoration and right-of-way management.</p> <p>Access road and tower construction.</p> <p>Right-of-way clearing and construction activities in general. Restoration following construction.</p> <p>Restoration and maintenance.</p> <p>As required during the operation of the line and maintenance of the right-of-way.</p> <p>At stream crossing during right-of-way clearing.</p> <p>At any time during construction as required During the installation of tower footings near watercourses.</p>

**TABLE J-1 (Continued)**  
**Examples of Typical Mitigation Measures**

<b>Environmental Concerns</b>	<b>Mitigation Measures</b>	<b>Application</b>
<b>FISH AND WILDLIFE (con't)</b>		
Impediment to the mitigation of fish or wildlife.	- avoid filling small wetlands serving as staging areas for waterfowl migration.	Small wetlands during access road and tower pad construction.
Impediment to the mitigation and/or breeding of fish or wildlife.	- installation and maintenance of proper stream crossing device.	At stream crossings during construction and as required for maintenance.
	- time construction activities to avoid disturbance to migrating fish and wildlife or during breeding.	During construction and maintenance.
	- follow Ontario Hydro standards for the application of herbicides near watercourses.	Near watercourses during line clearing and maintenance cycles.
Change in the chemistry of water bodies.	- minimize sedimentation of streams (see Water Quality).	Near watercourses during line clearing, construction and throughout the operation of the line.
	- prevent cut vegetation from entering watercourses.	Line clearing and maintenance cycles.
	- selective spraying or manual control of vegetation near watercourses.	Line clearing and maintenance cycles.
Increased water temperature as a result of clearing vegetation near streams.	- selective removal of vegetation; pruning.	At stream crossings during line clearing and maintenance cycles.
	- retain shrubby bank vegetation.	At stream crossings during line clearing and maintenance cycles.
<b>VEGETATION</b>		
Introduction of exotic plant species resulting from vegetation erosion control.	- use of native species for erosion control.	On areas where erosion control is necessary.
Vegetation stress due to nutrient loss as a result of soil deterioration.	- erosion control measures.	The management of the right-of-way erosion prone slopes.
Changes in vegetation due to soil disturbance (topsoil-subsoil mixing).	- time construction/clearing to take advantage of stable soil conditions.	During construction and line clearing operations, maintenance cycles.
Loss of forested land	- hectare for hectare reforestation.	Selection of clear cutting of transmission line right-of-way.
	- planting of wind breaks.	
	- landscaping plantings.	
<b>AGRICULTURE</b>		
Loss of standing crop due to access road and tower work site.	- limit width of access and size of tower site.	Agricultural areas - generally all construction/maintenance operations.
	- monetary compensation for crop loss.	Following determination of losses.
	- time construction to avoid growing season.	Construction/maintenance.
Soil Compaction	- scheduling activities to times of the year when soils are least susceptible to compaction.	Construction/maintenance.
	- stop activities when ground conditions are poor.	Construction/maintenance.
	- use of equipment with low bearing capacity.	Construction/maintenance.

**TABLE J-1 (Continued)**  
**Examples of Typical Mitigation Measures**

<b>Environmental Concerns</b>	<b>Mitigation Measures</b>	<b>Application</b>
<b>AGRICULTURE (Continued)</b>		
Soil Compaction (cont'd)	<ul style="list-style-type: none"> <li>- chisel ploughings</li> <li>- monetary compensation for subsequent crop reductions.</li> <li>- use of gravel roads.</li> <li>- locate access roads along existing traffic routes.</li> </ul>	<p>Restoration. Property settlements.</p> <p>Construction of new lines Construction/maintenance.</p>
Topsoil-subsoil mixing/soil rutting.	<ul style="list-style-type: none"> <li>- scheduling activities.</li> <li>- stop activity when ground conditions are poor.</li> <li>- use of equipment with low bearing capacity.</li> <li>- use of gravel roads.</li> <li>- backblading/grading.</li> <li>- addition of manures to offset fertility loss.</li> <li>- compensation for reduced soil productivity.</li> <li>- removal of soil and/or bentonite from foundation operations.</li> <li>- segregation of topsoil and subsoil.</li> </ul>	<p>Scheduling for construction/maintenance activities. Field decisions during construction phase of project. Construction/maintenance.</p> <p>Construction. Restoration. Restoration. As a result of negotiated settlement. Augured foundations.</p>
Disturbance to Farm Operations.	<ul style="list-style-type: none"> <li>- maintain contact with landowner/tenant regarding preferences.</li> </ul>	<p>Where required to prevent extensive mixing. Throughout construction and as maintenance work is required.</p>
Damage to Field Tiles.	<ul style="list-style-type: none"> <li>- avoidance of tile beds.</li> <li>- minimize tile crossings.</li> <li>- scheduling activities to times of the year when ground will support the equipment to be used.</li> <li>- use of soft track equipment.</li> <li>- protection of tile crossings by the placement of heavy steel plate.</li> <li>- stop activities when ground conditions are poor.</li> <li>- repair damaged drains.</li> <li>- compensate for damages.</li> </ul>	<p>Access road location landowner contact. Access road layout. All phases of construction/maintenance where the location of the tile drains is known. Construction/maintenance. Construction/maintenance.</p> <p>Field decision during construction phase of project. Restoration. As a result of negotiated settlement.</p>
Loss of Livestock	<ul style="list-style-type: none"> <li>- employ noise control measures near sensitive livestock.</li> <li>- construction of farm gates.</li> <li>- securing farm gates.</li> <li>- clean-up construction materials which could be ingested</li> </ul>	<p>During construction as required.</p> <p>Access road - construction. All activities. As an ongoing process throughout all phases of construction and maintenance.</p>
<b>SOCIETAL IMPACTS</b>		
Noise and Vibration	<ul style="list-style-type: none"> <li>- compensation for lost, injured livestock.</li> <li>- limit this type of work to daylight hours.</li> <li>- observe protocol or applicable municipal bylaws.</li> <li>- use of appropriate methods where available.</li> </ul>	<p>Following completion of construction, as a result of negotiations with claimant. All phases of construction where high noise levels could be a problem, e.g. residential areas. All phases of construction where high noise levels could be a problem, e.g. residential areas. As required - special circumstances; e.g. hospitals.</p>

**TABLE J-1 (Continued)**  
**Examples of Typical Mitigation Measures**

<b>Environmental Concerns</b>	<b>Mitigation Measures</b>	<b>Application</b>
<b>SOCIETAL IMPACTS</b>		
Mud and Dust.	<ul style="list-style-type: none"> <li>- wetting down dry soils.</li> <li>- chemical control of dust.</li> <li>- cleaning roads to remove mud.</li> <li>- temporary planting of grasses.</li> <li>- screen with natural or planted vegetation.</li> <li>- avoid linear access down the right-of-way.</li> <li>- addition of topsoil to gravel access roads.</li> <li>- hoarding construction sites.</li> <li>- installation of landscaping in advance of site completion.</li> </ul>	<p>All phases of construction.</p> <p>As required.</p> <p>As required.</p> <p>When the project duration permits and dust is a major problem,</p> <p>Access roads - right-of-way clearing; restoration.</p> <p>Access road location.</p> <p>Restoration of access roads.</p> <p>Station construction.</p> <p>Station construction.</p>
Appearance - Lines.	<ul style="list-style-type: none"> <li>- retain tree screens and curve access routes.</li> <li>- plant tree screens.</li> <li>- avoid sensitive soils for access routes.</li> <li>- stabilize erodible soils by vegetative or mechanical means.</li> <li>- add topsoil and seed gravel access routes.</li> </ul>	<p>Where appropriate vegetation exists.</p> <p>Where appropriate.</p> <p>Where possible.</p> <p>Where soils are subject to erosion.</p> <p>Where exposed to public view.</p>
Appearance - Stations.	<ul style="list-style-type: none"> <li>- paint hoarding to suit locale.</li> <li>- install landscaping treatment in advance.</li> </ul>	<p>Where appropriate.</p> <p>Where construction program and site size permits.</p>
Inconvenience.	<ul style="list-style-type: none"> <li>- select cable design to suit traffic conditions.</li> <li>- select timing of construction.</li> </ul>	<p>Where possible.</p> <p>Where scheduling permits.</p>
Heritage Resources.	<ul style="list-style-type: none"> <li>- structural and/or locational adjustments.</li> <li>- on and off site landscaping.</li> <li>- install suitable enclosures.</li> <li>- document and remove resource.</li> <li>- relocate electrical facilities.</li> </ul>	<p>As required.</p> <p>As required.</p> <p>As required.</p> <p>As required.</p> <p>As required.</p>

**Note:** The nature of the environment in the study area will determine the potential environmental effects for any project. Mitigation to address these effects will be determined on a case by case basis. Alternatives will be evaluated on the basis of net environmental effects (i.e., environmental effect - mitigation = net environmental effect).

## Appendix K

### Electric and Magnetic Fields

Since the 1960's, scientific interest and public concern have grown over possible health effects from electric and magnetic fields (EMF). There have been three main areas of research on these fields:

- Laboratory studies which have exposed cells, plants and animals to electric and magnetic fields to determine the effects and relevance, if any, to humans;
- Epidemiologic studies to examine the statistical relationship between the occurrence of disease and human exposure to these fields; and
- Exposure assessment to determine the amount of exposure that humans may encounter in homeoffice industries.

Some biological responses have been observed in certain studies. These responses have led to the hypothesis that long-term exposure may cause human health effects. Some epidemiologic studies have suggested a possible association between electric and magnetic fields and human health effects, while others have not.

Based on the evidence now available, the scientific community consensus (including the World Health Organization, Health & Welfare Canada and the Ontario Ministry of Health) is that a public health risk from exposure to any of these fields has not been established.

Public interest not only includes transmission and distribution lines but also household wiring and appliances (such as electric blankets), and commercial and industrial equipment (such as arc-welders).

#### Ontario Hydro Corporate Position

Since the 1970's, Ontario Hydro has funded research, monitored other study results and responded to public enquiries about the possible health effects of electric and magnetic fields associated with electric power generation and delivery systems.

Based on study results to date, there is no basis for Ontario Hydro to change existing practices for the generation, transmission, distribution and use of electricity

#### Ontario Hydro Research Program

Ontario Hydro will continue the following actions to develop reliable information on which decisions can be made to ensure occupational and public safety:

- (a) Monitor public and employee concerns, identify the need for and initiate further research and, if appropriate, make changes to design and operating practices;
- (b) Remain abreast of developments on the subject by monitoring worldwide scientific and research programs, judicial decisions, regulatory requirements

and operating practices and standards;

- (c) Develop and maintain a communication program to provide current information to all interested parties; and
- (d) Support continued health and safety research on an international level to ensure collection of the best possible data and their evaluation.

Ontario Hydro has launched the Electric and Magnetic Fields Risk Assessment Program (EMFRAP). EMFRAP will assess the health effects of electric and magnetic fields at power line frequencies of 60 hertz.

The program has started in 1988 and will run until 1993 at a total cost of about \$7 million. Ontario Hydro is co-sponsoring some of the studies and its share of the cost will be about \$3.5 million. The research program combines occupational, public health and laboratory studies in an effort to fill necessary information needs.

#### Occupational Health Studies

Occupational health studies are being carried out to ensure that safe working conditions are maintained. There are two main elements, one studying worker health statistics, and the other the levels of electric and magnetic fields exposure experienced by Hydro workers.

#### Public Health Studies

Public health studies will examine health statistics and electric and magnetic fields exposure data for the general public with particular emphasis on children.

These studies will also determine the sources of levels of 60 hertz electric and magnetic fields to which people are commonly exposed in their everyday lives.

#### Laboratory Studies

A laboratory study being conducted jointly with Health and Welfare Canada will investigate whether differing strengths of 60 Hz exposure influence the incidence or promote the development of cancer in rodents.

This study will be augmented by cellular investigations being carried out at the University of British Columbia. The results of this research will complement the occupational and public health investigations and enable a scientifically valid analysis of the human health studies.

#### Independent Scientific Review

An independent scientific review panel composed of members of the Royal Society of Canada, has scrutinized the EMFRAP design to ensure that the scientific studies are carried out properly and that The study results will withstand the examination of the world's scientific community.

The review panel will continue to monitor and comment on the studies until they are completed.