



# **GTA West**

## **REGIONAL INFRASTRUCTURE PLAN**

February 23, 2022



[This page is intentionally left blank]

**Prepared by:**

Hydro One Networks Inc. (Lead Transmitter)

**With support from:**

Company
Alectra Utilities Corporation (Alectra)
Burlington Hydro Electric Inc.
Halton Hills Hydro Inc.
Hydro One Networks Inc. (Distribution)
Independent Electricity System Operator
Milton Hydro Distribution Inc.
Oakville Hydro Electricity Distribution Inc.



# Disclaimer

This Regional Infrastructure Plan (“RIP”) report was prepared for the purpose of developing an electricity infrastructure plan to address electrical supply needs identified in previous planning phases and also any additional needs identified based on new and/or updated information provided by the RIP Working Group.

The preferred solution(s) that have been identified in this report may be reevaluated based on the findings of further analysis. The load forecast and results reported in this RIP report are based on the information provided and assumptions made by the participants of the RIP Working Group.

Working Group participants, their respective affiliated organizations, and Hydro One Networks Inc. (collectively, “the Authors”) make no representations or warranties (express, implied, statutory or otherwise) as to the RIP report or its contents, including, without limitation, the accuracy or completeness of the information therein and shall not, under any circumstances whatsoever, be liable to each other, or to any third party for whom the RIP report was prepared (“the Intended Third Parties”), or to any other third party reading or receiving the RIP report (“the Other Third Parties”), for any direct, indirect or consequential loss or damages or for any punitive, incidental or special damages or any loss of profit, loss of contract, loss of opportunity or loss of goodwill resulting from or in any way related to the reliance on, acceptance or use of the RIP report or its contents by any person or entity, including, but not limited to, the aforementioned persons and entities.

## EXECUTIVE SUMMARY

THIS REGIONAL INFRASTRUCTURE PLAN (“RIP”) WAS PREPARED BY HYDRO ONE WITH SUPPORT FROM THE TECHNICAL WORKING GROUP IN ACCORDANCE WITH THE ONTARIO TRANSMISSION SYSTEM CODE REQUIREMENTS. IT IDENTIFIES INVESTMENTS IN TRANSMISSION FACILITIES, DISTRIBUTION FACILITIES, OR BOTH, THAT SHOULD BE DEVELOPED AND IMPLEMENTED TO MEET THE ELECTRICITY INFRASTRUCTURE NEEDS WITHIN THE GTA WEST REGION.

The participants of the GTA West Regional Infrastructure Plan (“RIP”) Technical Working Group (“TWG”) included members from the following organizations:

- Alectra Utilities Corporation (“Alectra”)
- Burlington Hydro Electric Inc.
- Halton Hills Hydro Inc.
- Hydro One Networks Inc. (Distribution)
- Hydro One Networks Inc. (Transmission)
- Independent Electricity System Operator (“IESO”)
- Milton Hydro Distribution Inc.
- Oakville Hydro Electricity Distribution Inc.

This RIP is the final phase of the second cycle of the GTA West regional planning (RP) process and it follows the completion of the GTA West Integrated Regional Resource Plan (“IRRP”) [1] in August 2021; and the GTA West Needs Assessment (“NA”) [2] and Scoping Assessment (“SA”) in May 2019 and August 2019, respectively. This RIP provides a consolidated summary of needs and recommended plans for the GTA West Region over a 10-year planning horizon (2021-2031) based on available information. The load forecast for the 2032-2041 period is provided to show the longer term needs and trend. All needs for this long term horizon will be reviewed and confirmed in future regional planning cycles.

The first cycle of Regional Planning process was completed in January 2016 with the publication of the GTA West RIP [3], which provided a description of needs and recommendations of preferred wires plans to address near-term needs. Since the previous planning cycle the following projects have been completed:

- Halton Hills Hydro MTS (completed in 2018)
- Tremaine TS: Add 4 x 27.6 kV feeders (completed in 2020)

The recommended major infrastructure investments including assets replacements in the GTA West Region over the near and medium-term (2021-2031) period are given in Table 1 below, along with their planned in-service date and budgetary estimate for planning purposes.

**Table 1. GTA West Region - Recommended Plans over the 2021-2031 Study Period**

No.	Investments	I/S Date	Cost <sup>1</sup> (\$M)
<b>A</b>	<b>Increase Capacity</b>		
1	Palermo TS: Refurbish and Upgrade Transformers T3 and T4 and add new 27.6 kV yard	2026	30
2	Hurontario TS x Pleasant TS: Reconductor circuits H29/H30 with higher ampacity conductor	2027	8
<b>B</b>	<b>Asset Replacement</b>		
1	Bramalea TS: Replace Transformers T3 and T4	2028	20
2	Tomken TS: Replace Transformers T1 and T2	2029	49
3	Lorne Park TS: Replace Transformer T2	2030	14

<sup>1</sup> These costs are budgetary estimates for planning purposes unless otherwise specified

A number of potential capacity needs were also identified with the following facilities expected to exceed capacity limits over the medium to long term as listed below. The stations loading will continue to be monitored with medium term needs being managed at the distribution level utilizing capacity at adjacent area stations. All needs will be reviewed in the next regional planning cycle.

#### Medium Term Capacity Needs 2027 - 2031

- Pleasant TS: T1/T2 DESN – 2027
- Erindale TS: T1/T2 DESN – 2028
- Cardiff TS: T1/T2 DESN – 2029
- Erindale TS: T5/T6 DESN – 2031

#### Longer Term Capacity Needs 2032 – 2041

- Kleinburg TS: T1/T2 DESN – 2032
- Jim Yarrow MTS: T3/T4 DESN - 2032
- T38B/T39B: Lantz Jct x Trafalgar DESN – 2033
- Goreway TS: T5/T6 DESN - 2034
- Bramalea TS:T3/T4 DESN - 2036
- Tremaine TS: T1T2 DESN - 2039

The GTA West TWG recommends that:

- Hydro One and LDCs continue with the implementation of infrastructure investments listed in Table 1 while keeping the TWG apprised of project status;
- All the other identified needs/options are to be further reviewed by the TWG in the next regional planning cycle.

The next regional planning cycle for the GTA West Region must be triggered within five years, beginning with the Needs Assessment (“NA”) phase. It is expected that the next NA will start in Q1 2024. However, the next regional planning cycle can be started earlier if required to address any new emerging needs.

[This page is intentionally left blank]



[This page is intentionally left blank]

# TABLE OF CONTENTS

- Executive Summary ..... 5
- Table of Contents ..... 9
- List of Figures ..... 10
- List of Tables ..... 10
- 1. Introduction ..... 11
  - 1.1 Scope and Objectives ..... 13
  - 1.2 Structure ..... 13
- 2. Regional Planning Process ..... 14
  - 2.1 Overview ..... 14
  - 2.2 Regional Planning Process ..... 14
  - 2.3 RIP Methodology ..... 17
- 3. Regional Characteristics ..... 18
- 4. Transmission Facilities Completed and/or Underway in the Last Ten Years ..... 20
- 5. Forecast and Study Assumptions ..... 21
  - 5.1 Load Forecast ..... 21
  - 5.2 Other Study Assumptions ..... 22
- 6. Adequacy of Existing Facilities and Regional Needs ..... 23
  - 6.1 500 kV and 230 kV Transmission Facilities ..... 23
    - 6.1.1 500/230 kV Transformation Facilities ..... 23
    - 6.1.2 230 kV Transmission Circuits ..... 23
  - 6.2 Step-Down Transformation Facilities ..... 24
  - 6.3 Asset Replacement Needs for Major High Voltage (HV) Transmission Equipment ..... 25
  - 6.4 Load Security and Load Restoration ..... 26
    - 6.4.1 T38B/T39B Load Security ..... 26
    - 6.4.2 Load Restoration ..... 27
- 7. Regional Plans ..... 28
  - 7.1 Palermo TS: T3/T4 Replacement and Milton Hydro Capacity Requirements ..... 28
    - 7.1.1 Description ..... 28
    - 7.1.2 Alternatives and Recommendation ..... 29
  - 7.2 230 kV Circuits H29/H30 Conductor Upgrade ..... 30
    - 7.2.1 Description ..... 30
    - 7.2.2 Alternatives and Recommendation ..... 31
  - 7.3 230 kV Circuits R19TH/R21TH - Overload under certain outage conditions ..... 31
    - 7.3.1 Description ..... 31
    - 7.3.2 Alternatives and Recommendation ..... 32
  - 7.4 Station Capacity - DESN Stations Exceeding LTR ..... 32
  - 7.5 Asset Replacement for Major HV Transmission Equipment ..... 34
  - 7.6 Load Security – 230 kV circuits T38B/T39B ..... 34
    - 7.6.1 Load Security ..... 34
    - 7.6.2 Alternatives and Recommendations ..... 34

7.7	Load Restoration .....	35
7.8	Long Term Considerations .....	35
7.8.1	Capacity needs for 2032-2041 .....	35
7.8.2	Long-Term Growth & NWGTA Electricity Corridor Need .....	35
8.	Conclusions .....	36
9.	References .....	37
Appendix A.	GTA West Region - Stations .....	38
Appendix B.	GTA West Region - Transmission Lines .....	39
Appendix C.	GTA West Region - Distributors .....	40
Appendix D.	GTA West Region - Stations Load Forecast.....	41
Appendix E.	List of Acronyms .....	43

## LIST OF FIGURES

Figure 1-1	GTA West Region Map.....	12
Figure 2-1	Regional Planning Process Flowchart.....	16
Figure 2-2	RIP Methodology .....	17
Figure 3-1	GTA West Region Single Line Diagram .....	19
Figure 5-1	GTA West Region Non-Coincident Net Summer Peak Load Forecast.....	21
Figure 7-1	Palermo TS.....	29
Figure 7-2	Radial Circuits of H29/H30 Supplying Pleasant TS .....	31
Figure 7-3	Supply to Jim Yarrow MTS and Pleasant TS.....	32
Figure 7-4	GTA West Region - Pleasant TS, Cardiff TS and Erindale TS.....	33

## LIST OF TABLES

Table 6-1	GTA West Region - Lines Sections Exceeding ratings.....	24
Table 6-2	GTA West Region - Step-Down Transformer Stations .....	24
Table 6-3	GTA West Region - Step-Down Transformer Stations Requiring Relief .....	25
Table 6-4	GTA West Region - Planned Replacement Work .....	25
Table 6-5	GTA West Region – Load connected to 230kV double circuit line T38B/T39B.....	26
Table 6-6	GTA West Region – Load Connected to Various Transmission Lines .....	27
Table 7-1	GTA West Region – Identified Near, Medium-Term and Long Term Needs.....	28
Table 7-2	Palermo TS Load Forecast .....	29
Table 7-3	Forecast Loads on DESNs Overloaded during Plan Period .....	33
Table 7-4	GTA West Region – Asset Replacement Plans.....	34
Table 8-1	Recommended Plans in Toronto Region over the Next 10 Years .....	36

# 1. INTRODUCTION

## THIS REPORT PRESENTS THE REGIONAL INFRASTRUCTURE PLAN (“RIP”) TO ADDRESS THE ELECTRICITY NEEDS OF THE GTA WEST REGION.

The report was prepared by Hydro One Networks Inc. (Transmission) (“Hydro One”) on behalf of the Technical Working Group (“TWG”) in accordance with the regional planning process established by the Ontario Energy Board (“OEB”) in 2013. The Working Group included members from the following organizations:

- Alectra Utilities Corporation (“Alectra”)
- Burlington Hydro Electric Inc.
- Milton Hydro Distribution Inc.
- Halton Hills Hydro Inc.
- Hydro One Networks Inc. (Distribution)
- Hydro One Networks Inc. (Transmission)
- Independent Electricity System Operator (“IESO”)
- Oakville Hydro Electricity Distribution Inc.

The GTA West Region encompasses the municipalities of Brampton, southern Caledon, Halton Hills, Mississauga, Milton, and Oakville<sup>1</sup>. The region includes the area roughly bordered geographically by Highway 27 to the northeast, Highway 427 to the southeast, Regional Road 25 to the west, King Street to the north and Lake Ontario to the south, as shown in Figure 1-1.

Bulk electricity in the region is supplied by Burlington TS from the west, Claireville TS from the north, Richview TS and Manby TS from the east, and from the 500/230 kV autotransformers at Trafalgar TS, and distributed by a network of 230 kV transmission lines and twenty (20) step-down transformer stations. The summer 2021 non-coincident peak load of the region was approximately 3184 MW.

---

<sup>1</sup> Some parts of the City of Burlington are also supplied from Palermo and Tremaine transformer stations, located in the GTA West region.

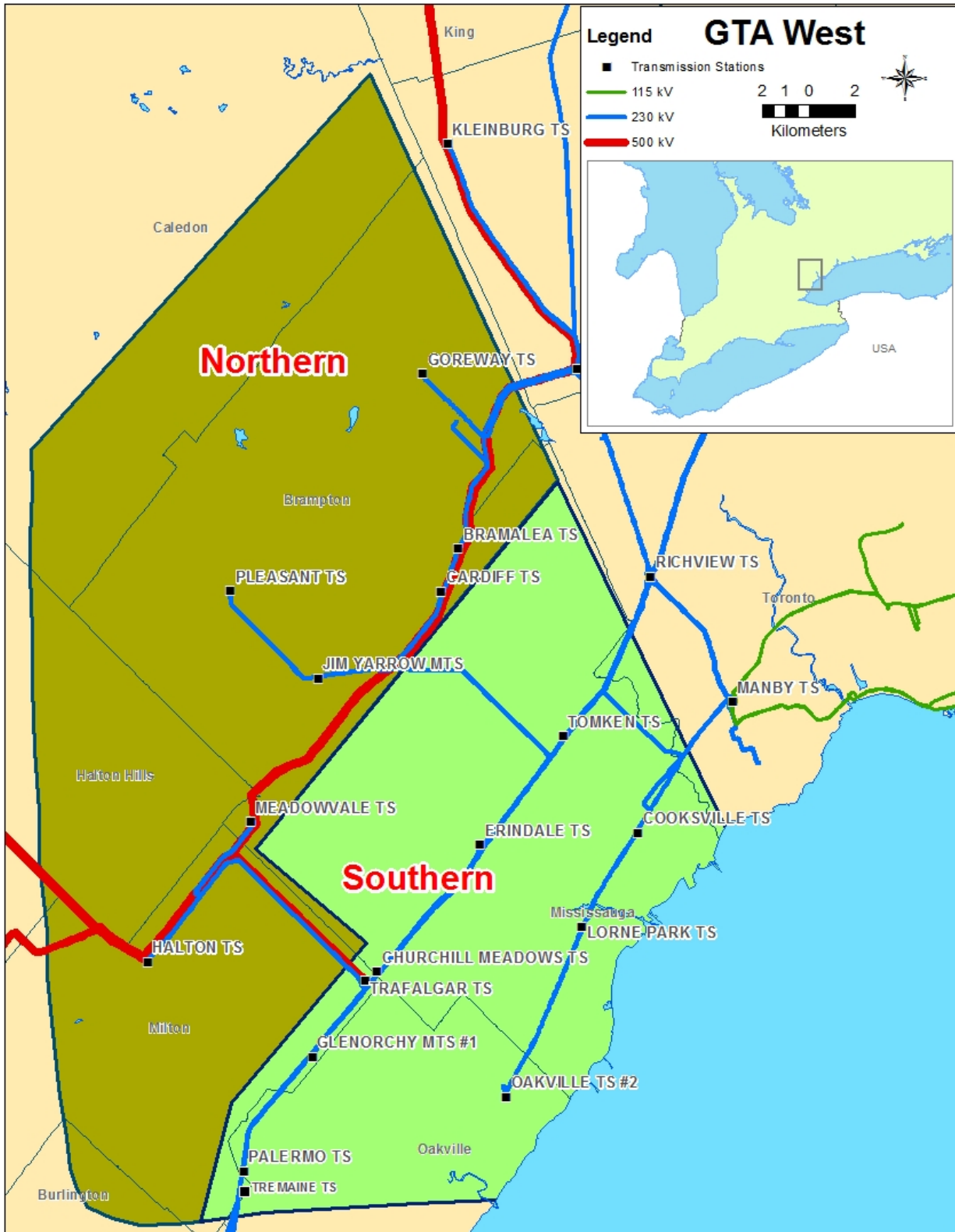

Figure 1-1 GTA West Region Map

## 1.1 Scope and Objectives

This RIP report examines the needs in the GTA West Region. Its objectives are to:

- Identify new supply needs that may have emerged since previous planning phases (e.g., Needs Assessment, Scoping Assessment, Local Plan, and/or Integrated Regional Resource Plan);
- Assess and develop wires plans to address these needs;
- Provide the status of wires planning currently underway or completed for specific needs;
- Identify investments in transmission and distribution facilities or both that should be developed and implemented on a coordinated basis to meet the electricity infrastructure needs within the region.

The RIP reviews factors such as the load forecast, transmission and distribution system capability along with any updates with respect to local plans, conservation and demand management (“CDM”), renewable and non-renewable generation development, and other electricity system and local drivers that may impact the need and alternatives under consideration.

The scope of this RIP is as follows:

- A consolidated report of the needs and relevant wires plans to address near and medium-term needs (2021-2031) identified in previous planning phases (Needs Assessment, Scoping Assessment, Local Plan, or Integrated Regional Resource Plan);
- Identification of any new needs over the 2021-2031 period and wires plans to address these needs based on new and/or updated information;
- Consideration of long-term needs identified by the TWG.

## 1.2 Structure

The rest of the report is organized as follows:

- Section 2 provides an overview of the regional planning process;
- Section 3 describes the region;
- Section 4 describes the transmission work completed over the last ten years;
- Section 5 describes the load forecast and study assumptions used in this assessment;
- Section 6 describes the results of the adequacy assessment of the transmission facilities and identifies the needs;
- Section 7 discusses the needs and provides the alternatives and preferred solutions; and,
- Section 8 provides the conclusion and next steps.

## 2. REGIONAL PLANNING PROCESS

### 2.1 Overview

Planning for the electricity system in Ontario is done at essentially three levels: bulk system planning, regional system planning, and distribution system planning. These levels differ in the facilities that are considered and the scope of impact on the electricity system. Planning at the bulk system level typically looks at issues that impact the system on a provincial level, while planning at the regional and distribution levels looks at issues on a more regional or localized level.

Regional planning looks at supply and reliability issues at a regional or local area level. Therefore, it largely considers the 115 kV and 230 kV portions of the power system that supply various parts of the province.

### 2.2 Regional Planning Process

A structured regional planning process was established by the Ontario Energy Board in 2013 through amendments to the Transmission System Code (“TSC”) and Distribution System Code (“DSC”). The process consists of four phases: the Needs Assessment<sup>2</sup> (“NA”), the Scoping Assessment (“SA”), the Integrated Regional Resource Plan (“IRRP”), and the Regional Infrastructure Plan (“RIP”).

The regional planning process begins with the NA phase which is led by the transmitter to determine if there are regional needs. The NA phase identifies the needs and the Technical Working Group (TWG) determines whether further regional coordination is necessary to address them. If no further regional coordination is required, further planning is undertaken by the transmitter and the impacted local distribution company (“LDC”) or customer and a Local Plan (“LP”) is developed to address them. These needs are local in nature and can be best addressed by a straight forward wires solution.

In situations where identified needs require further coordination at the regional or sub-regional levels, the IESO initiates the SA phase. During this phase, the IESO, in collaboration with the TWG, reviews the information collected as part of the NA phase, along with additional information on potential non-wires alternatives, and makes a decision on the most appropriate regional planning approach. The approach is either a RIP, which is led by the transmitter, or an IRRP, which is led by the IESO. If more than one sub-region was identified in the NA phase, it is possible that a different approach could be taken for different sub-regions.

The IRRP phase will generally assess infrastructure (wires) versus resource (CDM and Distributed Generation) options at a higher or more macro level, but sufficient to permit a comparison of options. If the IRRP phase identifies that infrastructure options may be most appropriate to meet a need, the RIP phase will conduct detailed planning to identify and assess the specific wires alternatives and recommend a preferred wires solution. Similarly, resource options which the IRRP identifies as best suited to meet a need are then further planned in greater detail by the IESO. The IRRP phase also includes IESO led

---

<sup>2</sup> also referred to as Needs Screening

stakeholder engagement with municipalities and establishes a Local Advisory Committee (LAC) in the region or sub-region.

The RIP phase is the final stage of the regional planning process and involves confirmation of previously identified needs; identification of any new needs that may have emerged since the start of the planning cycle; and development of a wires plan to address these needs. This phase is led and coordinated by the transmitter and the deliverable of this stage is a comprehensive and consolidated report of a wires plan for the region. Once completed, this report can be referenced in rate filing submissions and as part of LDC rate applications with a planning status letter provided by the transmitter to the LDC(s). Respecting the OEB timeline provision of the RIP, plan level stakeholder engagement is not undertaken during this phase. However, stakeholder engagement at a project specific level will be conducted as part of the project approval requirement.

To efficiently manage the regional planning process, Hydro One has been undertaking wires planning activities in collaboration with the IESO and LDCs for the region as part of and/or in parallel with:

- Planning activities that were already underway in the region prior to the regional planning process taking effect;
- The NA, SA, IRRP and LP phases of regional planning;
- Conducting wires planning as part of the RIP for the region or sub-region;
- Planning for connection capacity requirements with the LDCs and transmission connected customers.

Figure 2 -1 illustrates the various phases of the regional planning process (NA, SA, IRRP, and RIP) and their respective phase trigger, lead, and outcome.

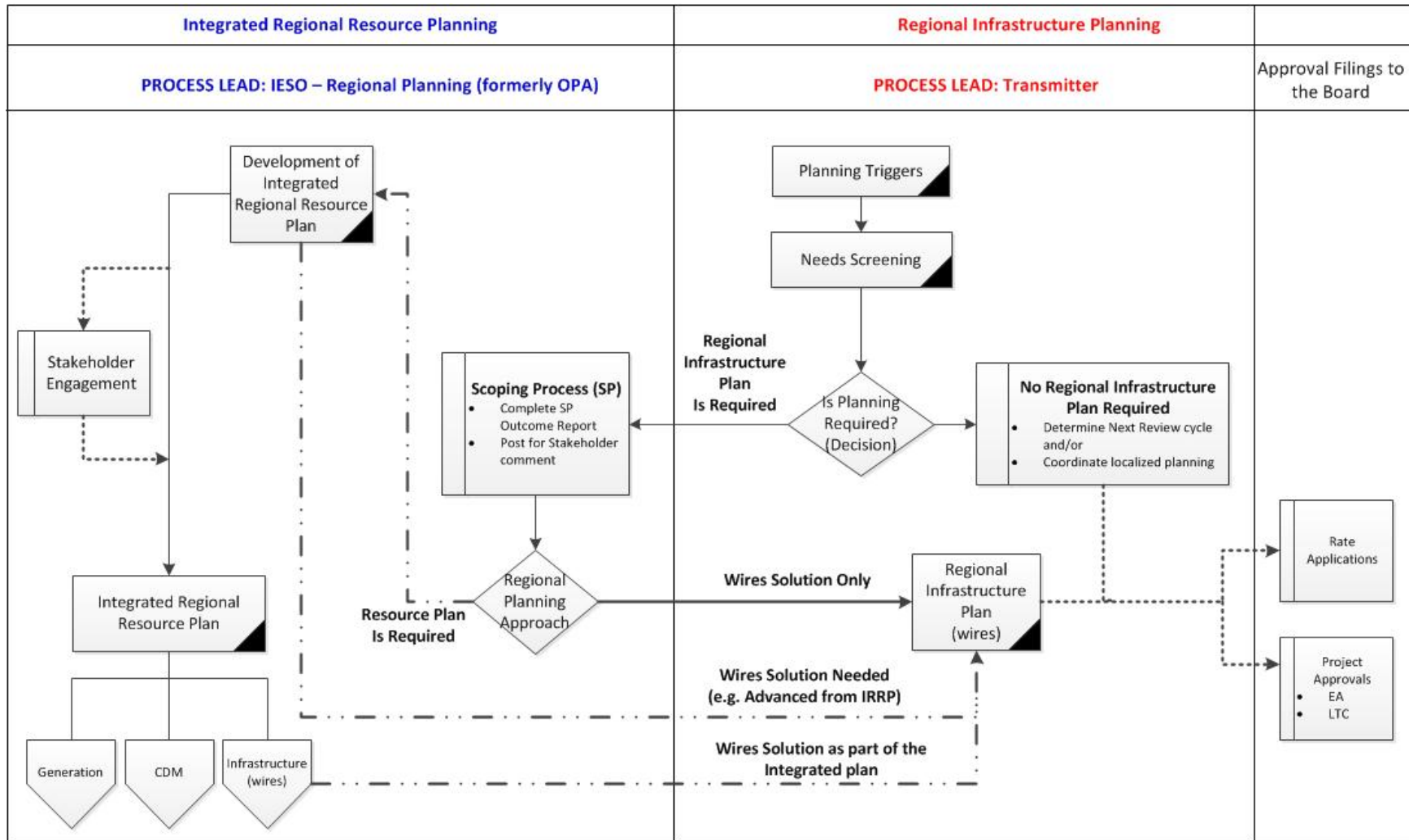

Figure 2-1 Regional Planning Process Flowchart



## 2.3 RIP Methodology

The RIP phase consists of four steps (see Figure 2-2) as follows:

1. **Data Gathering:** The first step of the RIP process is the review of planning assessment data collected in the previous stages of the regional planning process. Hydro One collects this information and reviews it with the Working Group to reconfirm or update the information as required. The data collected includes:
  - Net peak demand forecast at the transformer station level. This includes the effect of any distributed generation or conservation and demand management programs.
  - Existing area network and capabilities including any bulk system power flow assumptions.
  - Other data and assumptions as applicable such as asset conditions, load transfer capabilities, and previously committed transmission and distribution system plans.
2. **Technical Assessment:** The second step is a technical assessment to review the adequacy of the regional system including any previously identified needs. Additional near and medium-term needs may be identified at this stage.
3. **Alternative Development:** The third step is the development of wires options to address the needs and to come up with a preferred alternative based on an assessment of technical considerations, feasibility, environmental impact and costs.
4. **Implementation Plan:** The fourth and last step is the development of the implementation plan for the preferred alternative.

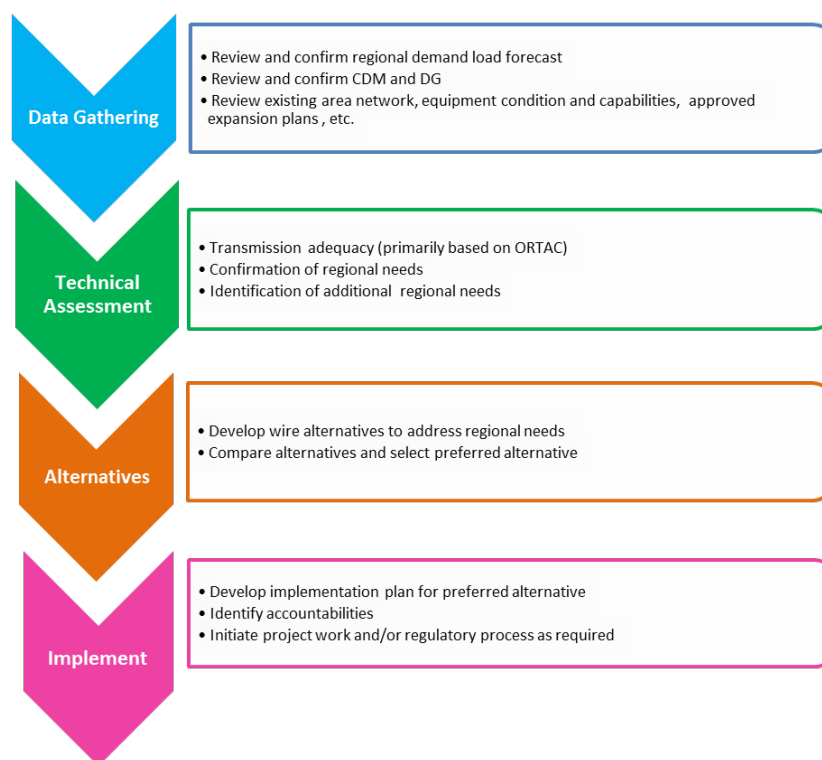

**Figure 2-2 RIP Methodology**

### 3. REGIONAL CHARACTERISTICS

THE GTA WEST REGION COVERS THE REGIONAL MUNICIPALITIES OF HALTON AND PEEL AND INCLUDES THE MUNICIPALITIES OF BRAMPTON, SOUTHERN CALEDON, HALTON HILLS, MISSISSAUGA, MILTON, AND OAKVILLE. THE REGION INCLUDES THE AREA ROUGHLY BORDERED GEOGRAPHICALLY BY HIGHWAY 27 TO THE NORTH-EAST, HIGHWAY 427 TO THE SOUTH-EAST, REGIONAL ROAD 25 TO THE WEST, KING STREET TO THE NORTH AND LAKE ONTARIO TO THE SOUTH.

Bulk electricity in the region is supplied by Burlington TS from the west, Claireville TS from the north, Richview TS and Manby TS from the east, and from the 500/230 kV autotransformers at Trafalgar TS, and distributed by a network of 230 kV transmission lines and twenty (20) step-down transformer stations (see Appendix A and B for a complete list). The distribution system in this Region is at two voltage levels, 44 kV and 27.6 kV. Local generation in the area include the two gas fired plants, the 1250 MW Sithe Goreway GS in Brampton and the 683 MW Halton Hills GS in Halton Hills.

The Local Distribution Customers (LDC) in the GTA West Region are Alectra Utilities Co., Burlington Hydro Inc., Halton Hills Hydro Inc., Hydro One Networks Inc., Milton Hydro Distribution Inc. and Oakville Hydro Electricity Distribution Inc. A listing of the LDCs along with the associated supply stations is given in Appendix C. The high-voltage system in this Region also provides supply to one direct transmission connected customer's transformer station. An electrical single line diagram for the GTA West Region facilities is shown in Figure 3-1.

Kleinburg TS is located near Bolton, Ontario and has been part of the GTA North regional planning process. However, majority of the Kleinburg TS transformational capacity is being used to supply communities located into GTA West region. Due to this reason, the Kleinburg TS has been included as part of the GTA West Regional Planning process as well.

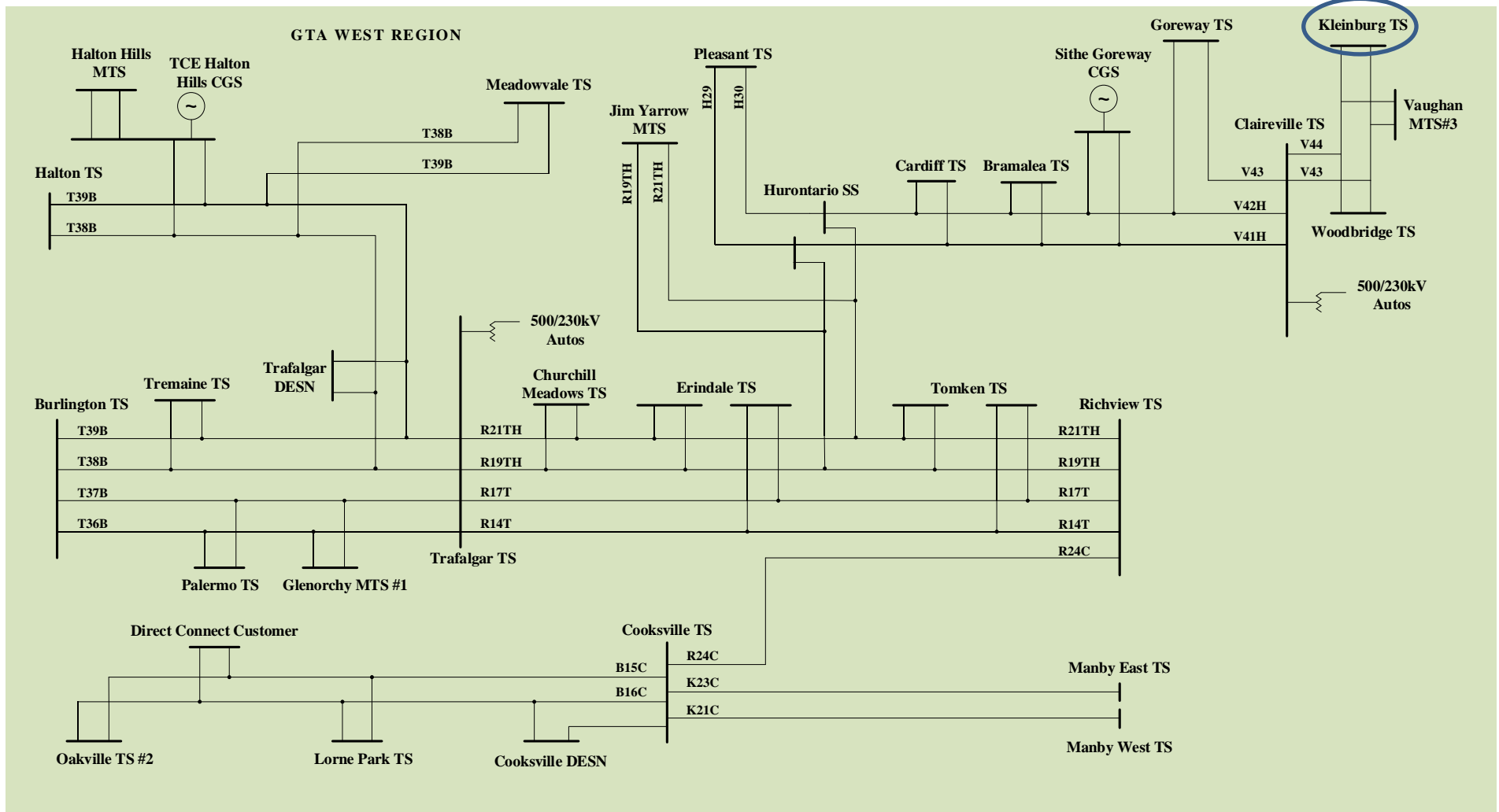

Figure 3-1 GTA West Region Single Line Diagram

## 4. TRANSMISSION FACILITIES COMPLETED AND/OR UNDERWAY IN THE LAST TEN YEARS

IN THE LAST TEN YEARS A NUMBER OF TRANSMISSION PROJECTS HAVE BEEN PLANNED AND UNDERTAKEN BY HYDRO ONE, OR ARE UNDERWAY, AIMED AT IMPROVING THE SUPPLY CAPABILITY AND RELIABILITY IN THE GTA WEST REGION.

A summary and brief description of the major projects completed and/or currently underway over the last ten years is provided below:

- Churchill Meadows TS (2010) – built a new step down transformer station consisting of two 75/125 MVA transformers in Mississauga supplied from 230 kV circuits R19TH and R21TH. This station provided additional load meeting capability to meet Alectra Inc. requirements.
- Hurontario SS and underground cable work (2010) - built a new switching station Hurontario SS, 4.2 km of double circuit 230 kV Line from Hurontario SS to Cardiff TS and 3.3 km of underground cable from Hurontario SS to Jim Yarrow MTS. The new switching station and associated line work connects the R19T/R21T circuits and the V42/V43H circuits to provide relief and improved reliability to Pleasant TS and Jim Yarrow MTS.
- Halton Hills GS (2010) – connected a new 683 MW gas-fired combined cycle generation station in Halton Hills connected to 230 kV circuits T38B and T39B. This generation station provided necessary local power to supply the GTA West Region.
- Glenorchy MTS#1 (2011) – connected new Oakville Hydro-owned Glenorchy MTS to 230 kV circuits T36B and T37B. This station provided additional load meeting capability to meet Oakville Hydro requirements
- Tremaine TS (2012) – built a new step down transformer station consisting of two 75/125 MVA transformers in Burlington supplied from 230 kV circuits T38B and T39B. This station provided additional load meeting capability to meet Burlington Hydro and Milton Hydro requirements.
- Richview TS x Trafalgar TS 230 kV Line Upgrade (Currently Underway) – The two 230 kV double circuits lines R14T/R17T and R19TH/T21TH between Richview TS and Trafalgar TS are being upgraded to provide additional bulk power transfer capability. The planned in-service date is Q2 2026.
- In addition to Hydro One, Halton Hills Hydro has also built the new Halton Hills Hydro MTS in 2019. This is a 230/28kV station with two 50/83MVA transformers and is connected to the 230 kV bus of the Halton Hills GS. This station has provided load meeting capability to supply Halton Hills Hydro loads.

## 5. FORECAST AND STUDY ASSUMPTIONS

### 5.1 Load Forecast

The load in the GTA West Region is expected to grow at an average rate of approximately 1.6% annually from 2021 to 2031, and 1.2% annually from 2031 to 2041. The growth rate varies across the region ranging from 1.4% in the Central Mississauga area to 2.4% in the West Oakville /Milton/Halton Hills area.

Figure 5-1 shows the GTA West Region extreme summer weather net load forecast from 2021 to 2041. The forecast shown is the regional non-coincident forecast, representing the sum of the load in the area for the 20 step-down transformer stations. The regional non-coincident peak load is forecast to increase from approximately 3184 MW in 2021 to 4212 MW in 2041. Non-coincident forecast for the individual stations in the region is available in Appendix D, and is used to determine any need for station capacity relief.

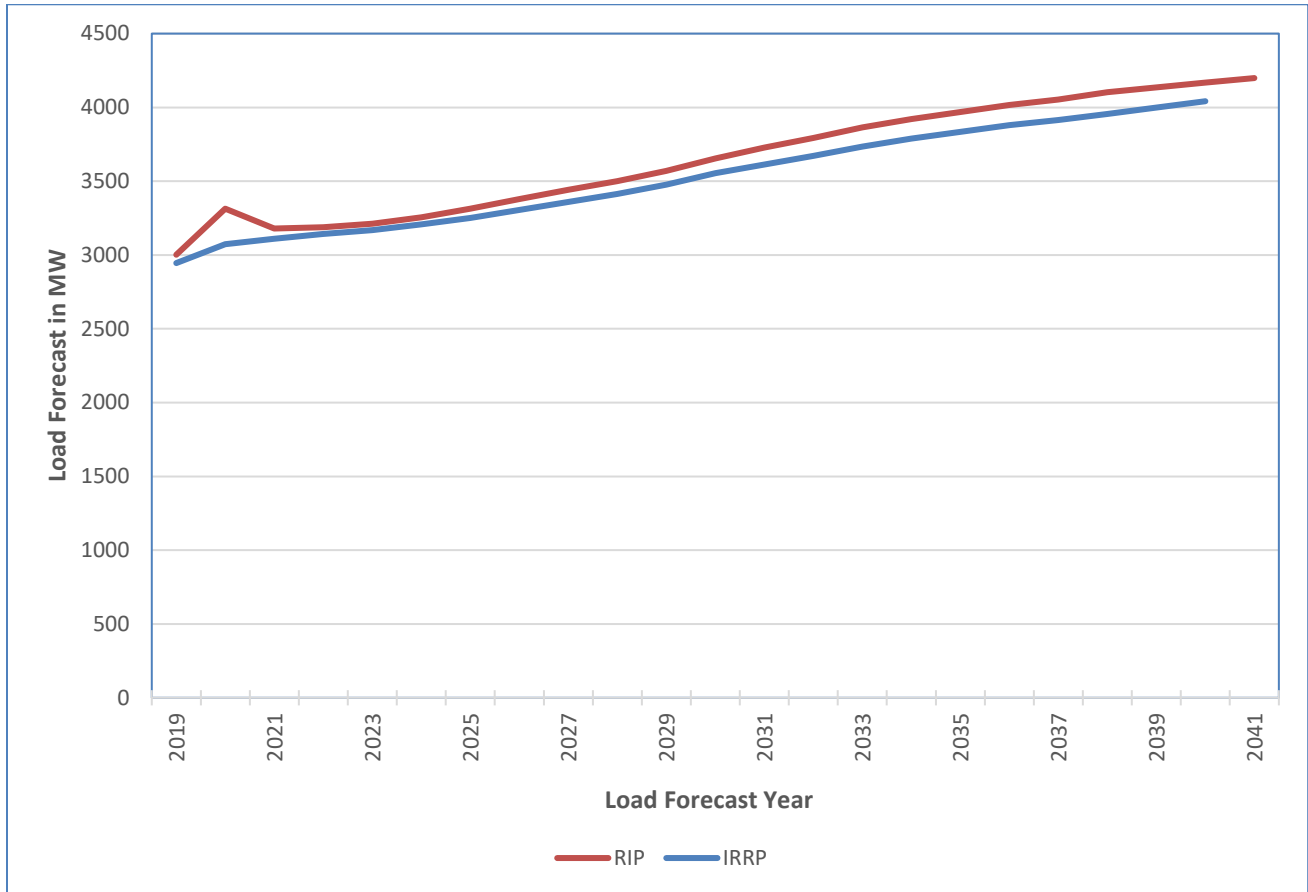

**Figure 5-1 GTA West Region Non-Coincident Net Summer Peak Load Forecast**

The regional non-coincident load forecast was developed by projecting the 2021 summer peak loads corrected for extreme weather, using the area stations growth rates as per the July 2021 IESO GTA West IRRP with

subsequent additional load forecast information provided by Alectra and Milton Hydro<sup>3</sup>. The IRRP forecast is shown for comparison. The growth rate accounts for CDM measures and connected DG. Details on CDM and connected DG information used to update the stations forecast in this report are provided in the GTA West IRRP [3] and are not repeated in this report.

## 5.2 Other Study Assumptions

The following other assumptions are made in this report.

- The study period for the RIP assessments is 2021-2031. However, a longer term forecast up to 2041 is provided to identify long-term needs and align with the IESO GTA West IRRP.
- All planned facilities for which work has been initiated and are listed in Section 4 are assumed to be in-service.
- Summer is the critical period with respect to line and transformer loadings. The assessment is based therefore based on summer peak loads.
- Station capacity adequacy is assessed by comparing the non-coincident peak load with the station's normal planning supply capacity, assuming a 90% lagging power factor for stations having no low-voltage capacitor banks and 95% lagging power factor for stations having low-voltage capacitor banks, or on the basis of historical power factor data.
- Normal planning supply capacity for transformer stations in the region is determined by the summer 10-day Limited Time Rating (LTR).
- Line capacity adequacy is assessed by using peak loads in the area.

---

<sup>3</sup> As a result of the need to refurbish Palermo TS and the decision to upgrade the station transformers (see Section 7.1), Milton Hydro plan to increase the loading on Palermo TS and have reduced their forecast for Halton TS.

## 6. ADEQUACY OF EXISTING FACILITIES AND REGIONAL NEEDS

THIS SECTION REVIEWS THE ADEQUACY OF THE EXISTING TRANSMISSION SYSTEM AND TRANSFORMER STATION FACILITIES SUPPLYING THE GTA WEST REGION AND LISTS THE FACILITIES REQUIRING REINFORCEMENT OVER THE 2021-2031 PERIOD.

Within the current regional planning cycle, three regional assessments have been conducted for the GTA West Region. The findings of these assessments are inputs to this RIP. These assessments are:

- 1) GTA West Region Needs Assessment (NA) Report, May 9, 2019
- 2) GTA West Region Scoping Assessment (SA) Report, August 8, 2019
- 3) GTA West (Peel Halton) Integrated Regional Resource Plan (IRRP) and Appendices, July 2021

The NA and IRRP reports identified a number of needs as a result of the forecasted load demand and condition of major high voltage transmission assets. This section reviews the adequacy of the transmission lines and stations in the GTA West Region based on the updated regional load forecast provided in Appendix D. Sections 6.1 to 6.2 present the results of this review. Asset replacement needs identified in the previous NA report are discussed in Section 6.3 of this report. Load security and load restoration needs are discussed in Section 6.4.

### 6.1 500 kV and 230 kV Transmission Facilities

All 500 kV and 230 kV transmission circuits in the GTA West Region with the exception of the Hurontario SS to Pleasant TS 230 kV circuits H29 and H30 are classified as part of the Bulk Electricity System (“BES”). They connect the Region to the rest of Ontario’s transmission system. The 230 kV circuits also serve local area stations within the region and the power flow on them depends on the bulk system transfers as well as the local area loads.

#### 6.1.1 500/230 kV Transformation Facilities

Bulk power supply to the GTA West Region is provided by 500/230 kV autotransformers at Trafalgar TS and Claireville TS, as well as 230 kV supply from Burlington TS, Richview TS and Manby TS. Additional support is provided from the 230 kV generation facilities at Halton Hills GS and Sithe Goreway GS. Both Claireville TS and Trafalgar TS are expected to require relief in the 2030s.

#### 6.1.2 230 kV Transmission Circuits

The 230kV circuits in the region are as follows (please refer to Figure 3-1):

1. Claireville TS to Hurontario SS (230 kV Circuits V41H, V42H, V43) – Supply Bramalea TS, Cardiff TS, and Goreway TS
2. Hurontario SS to Pleasant TS (230 kV Circuits H29, H30) – Supply Pleasant TS

3. Trafalgar TS to Burlington TS (230 kV Circuits T36B, T37B, T38B, T39B) – Supply Glenorchy MTS #1, Palermo TS, and Tremaine TS
4. Trafalgar TS to Halton TS (Radial Tap from 230 kV Circuits T38B, T39B) – Supply Trafalgar DESN, Meadowvale TS and Halton TS
5. Richview TS to Trafalgar TS (230 kV Circuits R14T, R17T) – Supply Erindale TS and Tomken TS
6. Richview TS to Trafalgar TS, with tap to Hurontario SS (230 kV Circuits R19TH, R21TH) – Supply Churchill Meadows TS, Erindale TS, Jim Yarrow MTS, and Tomken TS
7. Richview TS and Manby TS to Cooksville TS (230 kV Circuits R24C, K21C, K23C, B15C, B16C) – Supply Cooksville DESN, Ford Oakville CTS, Lorne Park TS, and Oakville TS #2.

The Richview TS x Trafalgar TS 230 kV circuits, R14T/R17T and R19TH/R21TH, are part of the “Flow East toward Toronto” interface (“FETT”) and the flow on these circuits is expected to increase as a result of the change in generation resource following the retirement of the Pickering Nuclear Generating Station in 2025. As the result, these circuits need to be upgraded. OEB Leave to Construct (“Section 92”) approvals have been obtained for the project and work is underway on re-conductoring these circuits with new conductors that have a 2000A summer continuous rating. The planned in-service date for the project is Q2 2026.

Other line sections expected to exceed their ratings during the study period are listed in Table 6-1 below.

**Table 6-1 GTA West Region - Lines Sections Exceeding ratings**

No.	Line	Section	Contingency	Line Rating MW	Year Line Rating exceeded
1	H29/H30	Hurontario SS x Pleasant TS	N-1 <sup>1</sup>	419	2027
2	T38B/T39B	Lantz Jct x Trafalgar DESN	N-1 <sup>1</sup>	535	2033
3	R19TH/R21TH	Hanlan Jct x Hurontario TS	N-1-1 <sup>2,3</sup>	416	2021

<sup>1</sup> Loss of one circuit of the double circuit line

<sup>2</sup> R19TH is overloaded when H29 and V42H are out of service

<sup>3</sup> R21TH is overloaded when H30 and V41H are out of service

The planned solutions to address these needs are discussed further in Section 7 of the report.

## 6.2 Step-Down Transformation Facilities

There are a total of twenty (20) step-down transformer stations in the GTA West Region as listed in Table 6-2. Nineteen (19) supply electricity to LDCs and one is a transmission connected industrial customer station. Of the nineteen stations, three (3) are owned and operated by the LDCs.

The stations summer peak load forecast is given in Appendix D Table D-1.

**Table 6-2 GTA West Region - Step-Down Transformer Stations**

Bramalea TS	Glenorchy MTS#1	Kleinburg TS	Pleasant TS
Cardiff TS	Goreway TS	Lorne Park TS	Tomken TS
Churchill Meadows TS	Halton Hills MTS	Meadowvale TS	Trafalgar TS
Cooksville TS	Halton TS	Oakville TS #2	Tremaine TS
Erindale TS	Jim Yarrow MTS	Palermo TS	Customer #1 CTS



This RIP reviewed the step-down transformation capacity for the stations within the GTA West Region. The NA and IRRP studies had previously indicated that a second Halton TS DESN would be required by summer 2022. Subsequent to those studies, and as part of the discussions for this RIP, Milton Hydro provided a revised load forecast with new load being supplied from Glenorchy MTS #1, Halton Hills MTS, and Palermo TS. As a result of this update, the need for the second Halton TS DESN has been deferred to 2033. Based on the load forecast, the following stations would require capacity relief during the 2021-2031 study period as shown in Table 6-3 below. The need timeframe defines the time when the peak load forecast exceeds the DESN's Summer 10-day LTR.

**Table 6-3 GTA West Region - Step-Down Transformer Stations Requiring Relief**

Station	Capacity (MW)	2021 Loading (MW)	Need Date
Palermo TS: T1/T2 DESN refurbishment	110	124	2027
Pleasant TS: T1/T2 DESN	148	138	2027
Erindale TS: T1/T2 DESN	181	142	2028
Cardiff TS: T1/T2 DESN	113	103	2029
Erindale: T5/T6 DESN	185	142	2031

Further, based on the load forecast, the stations requiring relief beyond 2031 are listed below:

- Jim Yarrow MTS: T3/T4 DESN – 2032
- Kleinburg TS: T1/T2 DESN – 2032
- Goreway TS: T5/T6 DESN – 2034
- Bramalea TS: T3/T4 DESN – 2036
- Tremaine TS: T1/T2 DESN – 2039

### 6.3 Asset Replacement Needs for Major High Voltage (HV) Transmission Equipment

A number of Hydro One facilities in the GTA West Region will require replacement over the 2021-2031 study period. These needs are determined by asset condition based on a range of considerations such as equipment deterioration, technical obsolescence due to outdated design, lack of spare parts availability or manufacturer support, and/or potential health and safety hazards.

Asset replacement work is planned over the study period at area transformer stations listed in Table 6-4. Palermo TS work is discussed in Section 7.1. Details for the remaining stations are provided in Section 7.5.

**Table 6-4 GTA West Region - Planned Replacement Work**

No.	Station	Planned I/S Date
1	Palermo TS	2026
2	Bramalea TS	2028
3	Tomken TS	2029
4	Lorne Park TS	2030

## 6.4 Load Security and Load Restoration

Load security and load restoration needs were reviewed as part of the current study. For load security ORTAC requires that no more than 600 MW of load be lost as a result of a double circuit contingency.

Further, loads are to be restored in the restoration times specified as follows:

- All loads must be restored within 8 hours.
- Load interrupted in excess of 150 MW must be restored within 4 hours.
- Load interrupted in excess of 250 MW must be restored within 30 minutes.

### 6.4.1 T38B/T39B Load Security

The 2021 IRRP had identified that the loading on the double circuit 230kV line T38B/T39B corridor was forecast to exceed the 600 MW limit by 2025. However, as mentioned in Sections 5 and 6.2, Milton Hydro plan to increase loading on Palermo TS and have updated the forecast for Halton TS. As a result, the loading on T38B/T39B circuits has been reduced. The current revised forecast (See Table 6-5) indicates that the non-coincident connected load on the T38B/T39B circuits will exceed the 600 MW limit by 2030.

**Table 6-5 GTA West Region – Load connected to 230kV double circuit line T38B/T39B**

Circuit	Limit MW	Act.	Forecast - Connected Load (MW)										
			2021	2022	2023	2024	2025	2026	2027	2028	2029	2030	2031
T38B/T39B	600	523	516	529	555	566	580	578	584	598	613	631	843

This load security need is further discussed in section 7.6

## 6.4.2 Load Restoration

Load restoration needs in the Region were previously identified in the NA, SA and IRRP. These were again reviewed by the Working Group in the RIP. The lines, stations served and the loads at the end of the study period on the lines in the Region are given in Table 6-6 below:

**Table 6-6 GTA West Region – Load Connected to Various Transmission Lines**

No.	Lines/ Circuits	Connected Stations	Line Length (km)	Year 2031 Connected Load (MW)	Load subject to 30 minute criteria (MW)
1	B15/B16	Lorne Park TS, Oakville #2 TS	12.5	278	28
2	H29/H30	Pleasant TS	8.5	459	209
3	R14T/R17T	Erindale TS (T1/T2) & (T3/T4), Tomken T1/T2	21.7	479	229
4	R19TH/ R21TH	Churchill Meadows TS, Erindale TS (T5/T6), Tomken TS (T3/T4), Jim Yarrow TS	33.3	583	333
5	T36B/T37B	Palermo TS, Glenorchy MTS#1	24.5	272	22
6	T38B/T39B <sup>1</sup>	Tremaine TS, Trafalgar DESN, Halton TS, Meadowvale TS and Halton Hills MTS	42.7	631	381
7	V41H/V42H	Bramalea TS, Cardiff TS	17/26.3 <sup>2</sup>	435	185
8	V42H/V43	Goreway TS	17/21.4 <sup>2</sup>	269	19
9	V43/V44	Woodbridge TS, Vaughan MTS#3, Kleinburg TS <sup>3</sup>	21.4/12 <sup>2</sup>	498	248

<sup>1</sup> Trafalgar DESN, Halton TS, Meadowvale TS and Halton Hills TS are on a radial tap connected to the T38B/T39B line.

<sup>2</sup> Tap length for the two circuits are different

<sup>3</sup> Vaughan MTS#3 and Woodbridge TS are also supplied from the V43/V44 line and loads are taken from the 2020 GTA North RIP report.

The Table shows that all lines in the Region have connected load greater than 250MW. For lines 1, 5, 8 the load in excess of 250MW is small and transfers can be managed at the distribution levels. For all other lines, the load in excess of 250MW cannot be restored within 30 minutes. However, all lines are short; reliability of the lines is good and the incidents of overlapping outages very rare. The lines are located in the GTA, with good accessibility for maintenance crews and Hydro One expects all loads to be restored within 4 hours with at least one circuit back into service.

Any mitigation measure to meet the 30 minute restoration requires building new lines and/or installing additional switching facilities. The work will be extremely expensive and have substantial environmental and public impact. Given the past reliability performance and expectation to restore the load within 4 hours, the TWG does not recommend any further action.

## 7. REGIONAL PLANS

THIS SECTION DISCUSSES NEEDS, PRESENTS WIRES ALTERNATIVES AND THE PREFERRED WIRES OPTIONS FOR ADDRESSING THE ELECTRICAL SUPPLY NEEDS FOR THE GTA WEST REGION..

The electrical infrastructure needs for the GTA West Region are summarized in Table 7-1. These needs include those previously identified in the GTA West NA and IRRP as well as those resulting from the adequacy assessment carried out as part of this RIP report. The details of the project/plan to address these needs are provided in Sections 7.1 through 7.7.

**Table 7-1 GTA West Region – Identified Near, Medium-Term and Long Term Needs**

Section	Facilities	Need	Timing
7.1	Palermo TS	Transformers T3 and T4 replacement. Milton Hydro capacity requirements	2026
7.2	H29/H30: Hurontario TS x Pleasant TS	Line upgrade required to supply Pleasant TS	2027
7.3	R19TH/R21H	Overload under certain outage conditions	Existing
7.4	Pleasant TS: T1/T2 DESN	Load exceeding DESN capacity	2027
7.4	Erindale TS: T1/T2 DESN	Load exceeding DESN capacity	2028
7.4	Cardiff TS: T1/T2 DESN	Load exceeding DESN capacity	2029
7.4	Kleinburg TS: T1/T2 DESN	Load exceeding DESN capacity	2030
7.4	Erindale: T5/T6 DESN	Load exceeding DESN capacity	2031
7.5	Bramalea TS	Transformer T3 and T4 replacement	2028
7.5	Tomken TS	Transformers T1 and T2 replacement	2029
7.5	Lorne Park TS	Transformer T2 replacement	2030
7.6	Load Security	T38B/T39 Loading	2030
7.7	Load Restoration	ORTAC 30 minutes restoration criteria not met.	--- <sup>1</sup>
7.8	Longer Term Needs	Capacity Exceeded Lines - T38B/T39B: Lantz Jct x Trafalgar DESN Stations - Jim Yarrow MTS: T3/T4 DESN Kleinburg TS: T1/T2 (27.6kV) DESN Goreway TS: T5/T6 DESN Bramalea TS:T3/T4 DESN Tremaine TS: T1T2 DESN	2033 2032 2032 2034 2036 2039

<sup>1</sup>No action is planned. Please see sections 6.4.2 and 7.7.

### 7.1 Palermo TS: T3/T4 Replacement and Milton Hydro Capacity Requirements

#### 7.1.1 Description

Palermo TS is a 230/27.6 kV transformer station that facilitates load delivery to Burlington Hydro Inc., Milton Hydro Inc. and Oakville Hydro customers in the cities of Burlington, Milton and Oakville, respectively (see Figure 7-1). Peak station demand was about 124 MW in summer 2021 as compared to the station 10 day LTR of 110 MW.

The transformers, T3 and T4, at Palermo TS are over 50 years old and based on asset condition assessment require replacement in the near-term. The current plan is to replace these transformers by Q4 2026.

Palermo TS is currently a “restricted station” due to short circuit constraints and new DER resources cannot connect to feeders from the station.



**Figure 7-1 Palermo TS**

The earlier NA and IRRP reports had identified the need for adding a second DESN at Halton TS by 2022 and that the loading on Tremaine TS would be exceeded by 2033. The IRRP had also identified upsizing the Palermo TS transformers as a more cost effective alternative to replacing the transformer like for like. As part of this RIP, Milton Hydro reviewed their load forecast and now plan to utilize the increased capacity at Palermo TS, thereby deferring the need for a second DESN at Halton TS to 2033. The Palermo TS upgrade also defers the need for providing relief for Tremaine TS to 2039. The Palermo TS forecast is given below in Table 7-2 and reflects the revised loading provided by Milton Hydro and assumes that Burlington Hydro and Oakville Hydro existing load on Palermo TS remains constant.

**Table 7-2 Palermo TS Load Forecast**

Station	LTR (MW)	Act.	Load Forecast										
			2021	2022	2023	2024	2025	2026	2027	2028	2029	2030	2031
Palermo TS	110/180 <sup>1</sup>	124	115	113	113	112	112	129	133	134	135	137	155

<sup>1</sup>The station existing LTR is 110 MW. With new 75/125MVA transformers the LTR will increase to 180 MW.

**7.1.2 Alternatives and Recommendation**

The following alternatives were considered to address Palermo TS T3/T4 replacement need as well as meet future demand requirements:

- **Alternative 1 - Maintain Status Quo:** This alternative was considered and rejected as it does not address the risk of failure due to asset condition and would result in increased maintenance expenses and will not meet Hydro One’s obligation to provide reliable supply to the customers.

- **Alternative 2 – Replace T3/T4 with similar type and size equipment as per current standard:** Under this alternative the existing T3/T4 transformers at Palermo TS will be replaced with new 50/83 MVA, 230/27.6 kV transformers. This alternative would address the need and maintain reliable supply to the customers in the area. It would not however, provide additional capacity to meet the future load growth as per the load forecast. It would also not allow additional DER resources to connect to the station since the short circuit constraints will remain due to the lower impedances of the 50/83MVA transformers.
- **Alternative 3 – Replace T3/T4 with larger size 230/27.6 kV, 75/125MVA transformers:** This alternative would require replacing the existing T3/T4 transformers with larger size transformers. Since the new transformers will be dual-winding transformers, the existing low voltage switchyard will need to be modified and additional feeders added to utilize the increased capacity. The modified station will have dual 27.6 kV buses with reduced fault current level and station capacity will increase from current 110 MW to 180 MW. This alternative will thus provide additional capacity to meet future load growth and the reduced fault current will permit DER resources to connect to the station.

The TWG recommends Alternative 3 as the preferred and cost effective alternative for addressing the need and taking “right-sizing” into consideration. It provides capacity to meet future load growth, removes the restriction on DER to connect to the station, maintains reliable supply to the customers in the area while increasing system resiliency and flexibility. While the incremental cost difference between the 50/83MVA and the 75/125MVA transformers is small (<\$1M), planning estimates for the LV yard expansion and additional feeder positions are between \$7-10M.

## 7.2 230 kV Circuits H29/H30 Conductor Upgrade

### 7.2.1 Description

Pleasant TS is located in Brampton and has two 230/27.6 kV DESNs and one 230/44kV DESN. The station is supplied by the 230 kV double circuit line H29/H30 from Hurontario SS (see Figure 7-2). The station serves Alectra – Brampton loads. The summer 2021 peak station load was about 383 MW.

The existing conductor used for 230 kV circuits H29/H30 going to Pleasant TS is 795.0 kcmil ACSR 26/7 with summer long term emergency rating of 1090 A (at 127°C). This rating limits the maximum load-carrying capacity to approximately 419 MW of load at Pleasant TS. As mentioned in Table 6.1 the line flows are forecast to exceed line rating by summer 2027.



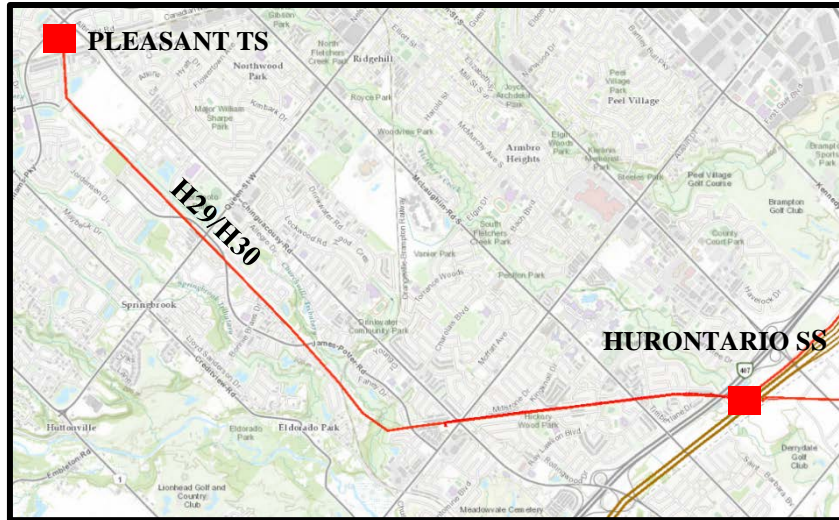

**Figure 7-2 Radial Circuits of H29/H30 Supplying Pleasant TS**

## 7.2.2 Alternatives and Recommendation

The following alternatives were considered to address upgrading of the H29/H30 line:

1. **Alternative 1 - Maintain Status Quo:** This alternative was considered and rejected as it does not provide adequate transmission capacity to supply the load demand at Pleasant TS.
2. **Alternative 2 – Upgrade Line conductor:** This alternative covers upgrading the line by replacing the existing conductor with a conductor with a higher current rating.

Other alternatives such as building a second 230 kV line to Pleasant TS or transferring load away from Pleasant TS were considered and ruled out as impractical and not cost effective.

The TWG recommends Alternative 2 as the technically preferred and cost effective alternative for reinforcing the supply to Pleasant TS. Hydro One will consider transmission losses while selecting the conductor. OEB approval under Section 92 of the Electricity Act will be required. The estimated cost of the project is about \$8M.

## 7.3 230 kV Circuits R19TH/R21TH - Overload under certain outage conditions

### 7.3.1 Description

The loads at Jim Yarrow MTS and Pleasant TS are supported by the 230 kV line V41H/V42H from Claireville and the R19TH/R21TH line as shown in Figure 7-3, Under certain outage conditions all loads at Pleasant TS and half the load on Jim Yarrow MTS can end up on one of the R19TH or the R21TH section between Hanlan Jct and Hurontario SS.

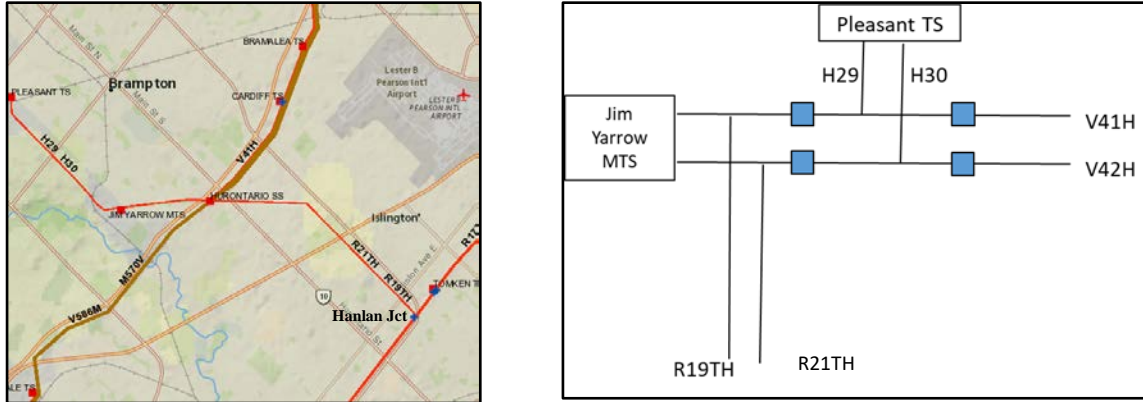

**Figure 7-3 Supply to Jim Yarrow MTS and Pleasant TS**

The two outage scenarios are:

- R19TH overloaded for overlapping outages of V41H and H30 (V41H out of service and H30 lost or H30 out of service and V41H lost).
- R21TH overloaded for overlapping outages of V42H and H29 (V42H out of service and H29 lost or H29 out of service and V42H lost).

### 7.3.2 Alternatives and Recommendation

The IRRP had considered a number of alternatives to address this issue ranging from a local load rejection scheme at Pleasant TS to reinforcing the supply to Hurontario SS.

Following discussions with IESO and Hydro One Operating groups, given the fact that the possibility of the overlapping outages is rare, manual operator action can be taken to relieve the line overloads and will be adequate over the near to medium-term (till 2030). Hydro One has implemented an operating procedure under which Jim Yarrow MTS load is transferred to R21TH if V41H or H30 are out of service pre-contingency and to R19TH if V42H or H29 are out of service pre-contingency.

The TWG recommends that the loading on the R19TH/R21TH and the performance of the manual scheme be monitored. The timing (currently forecast to be around 2030) and the preferred option alternative for the LR scheme will be reviewed in the next planning cycle.

### 7.4 Station Capacity - DESN Stations Exceeding LTR

As discussed in Section 6.2 the loading on five DESN stations – Palermo TS T3/T4, Erindale TS T1/T2, Pleasant TS T1/T2, Cardiff TS T1/T2, Erindale T5/T6 - is expected to exceed station LTR during the 2021-2031 study period. Palermo TS has been discussed in Section 7.1. The remaining stations are discussed here.

All these remaining DESNs supply Alectra utilities load. Erindale TS and Cardiff TS supply load in Mississauga and Pleasant TS supplies load in Brampton (Figure 7-4). The stations forecast loads and need dates are given in Table 7-3 below.



**Table 7-3 Forecast Loads on DESNs Overloaded during Plan Period**

Station	LTR MW	Act.	Load Forecast											Need Date
			2021	2022	2023	2024	2025	2026	2027	2028	2029	2030	2031	
Pleasant TS T1/T2 DESN	148	138	142	147	147	147	148	149	150	151	152	154	162	2027
Erindale TS T1/T2 DESN	181	142	147	151	156	162	168	175	182	190	192	195	211	2028
Cardiff TS T1/T2 DESN	114	103	102	100	99	102	106	110	114	119	120	121	128	2029
Erindale TS T5/T6 DESN	195	142	141	139	137	145	153	163	172	182	193	196	230	2031

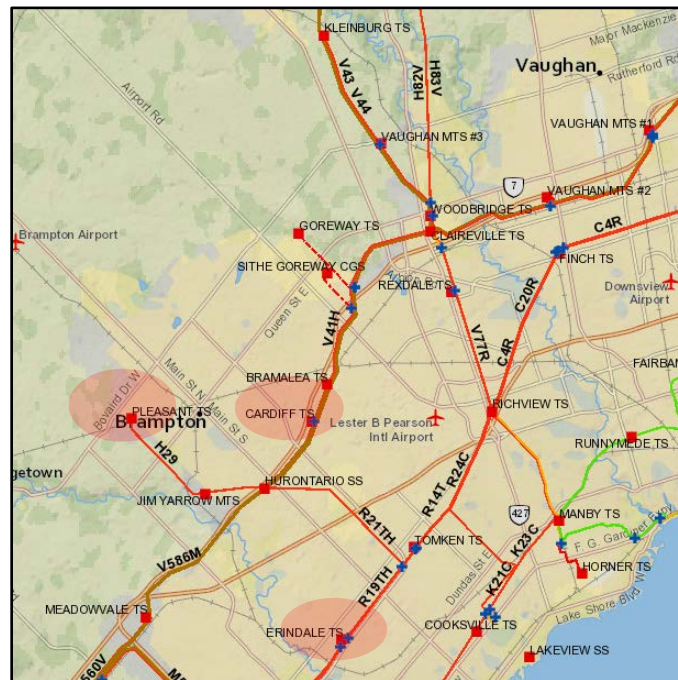

**Figure 7-4 GTA West Region - Pleasant TS, Cardiff TS and Erindale TS**

Options for providing the required relief for Erindale TS T1/T2 DESN were previously investigated in 2015 Local Planning Report for Erindale TS [4]. As discussed in the 2019 GTA West Region NA Report [2], this need is being managed by Alectra and no transmission upgrades are required.

The loading issues at the Pleasant TS T1/T2 DESN, Cardiff TS T1/T2 DESN, and the Erindale TS T5/T6 DESN are similar to those of Erindale T1/T2 DESN. The TWG recommends that these loading issues be managed at the Distribution level in the near term and it will be reviewing the station loadings in the next regional planning cycle.

## 7.5 Asset Replacement for Major HV Transmission Equipment

As discussed in Section 6.3, Hydro One has identified the need for replacement of major HV transmission assets over the next ten years at a number of GTA West Region Hydro One stations – Palermo TS, Bramalea TS, Tomken TS and Lorne Park TS –. Palermo TS T3/T4 replacement is discussed in section 7.1.

Details of the work at the remaining stations along with their planned in-service year are given in Table 7-4 below:

**Table 7-4 GTA West Region – Asset Replacement Plans**

No.	Station	Planned work	In-service year <sup>(1)</sup>
1	Bramalea TS	The work includes replacement of the 230/44kV, 50/83MVA transformers, T3 and T4 with larger size 230/44kV, 75/125MVA units.	2028
2	Tomken TS	The work includes like-for-like replacement of 230/44 kV, 75/125 MVA transformers T1 and T2.	2029
3	Lorne Park TS	The work includes like-for-like replacement of 230/27.6 kV, 50/83MVA transformer T2.	2030

(1) The planned in-service year is tentative and is subject to change

The above asset replacement plans have taken “right sizing” into consideration. Based on the load forecast, Bramalea TS T3/T4 transformers will be replaced with larger size 75/125MVA units as the load forecast indicates that increased capacity would be required by 2036. The Lorne Park TS T2 transformer is planned to be replaced with “like-for-like” 50/83MVA units and Tomken TS T1/T2 transformers will be replaced with “like-for-like” 75/125MVA units (which is the largest standard size for these transformers).

The TWG recommends that Hydro One proceed with the above work to ensure that the system meet reliability criteria and supply to customers is not affected.

## 7.6 Load Security – 230 kV circuits T38B/T39B

### 7.6.1 Load Security

As discussed in Section 6.4.1 loads connected to the 230 kV circuits T38B/T39B will exceed the 600 MW by summer 2030. The circuit T38B/T39B will not be able to meet the ORTAC supply security criteria, which states that no more than 600 MW can be interrupted by configuration.

### 7.6.2 Alternatives and Recommendations

There were a number of alternatives suggested in the IRRP to ensure compliance with the ORTAC load security criteria. These included sectionalizing the T38B/ T39B circuits using breakers or re-terminating the stations to reduce loads connected to the T38B/T39B circuits. However, as per the current forecast, load is not expected to exceed 600 MW till summer 2030 due to the lower than expected load at Halton TS and Milton Hydro supplying some of the projected area load from the upsized Palermo TS.

The TWG recommends that Hydro One continue to monitor the load and that it will review the the need the next regional planning cycle.

## 7.7 Load Restoration

Load restoration following outages was discussed in Section 6.4.2 As mentioned, there are a number of lines that do not meet the IESO criteria of the restoration of all load above 250 MW in 30 minutes.

However, given the high cost for mitigation measures, the low probability of the event happening and the ability to restore load within 4 hours, the TWG agrees that no further action is required.

## 7.8 Long Term Considerations

### 7.8.1 Capacity needs for 2032-2041

A number of capacity needs were identified in Section 6 over the longer term. These are summarized here.

1. Line capacity – Loading on a small 300m section of the T38B/T39B line, between Lantz Jct and Trafalgar DESN, will exceed the line rating by 2033.
2. Station Capacity – The following stations are expected to require relief:
  - Jim Yarrow MTS: T3/T4 DESN - 2032
  - Kleinburg TS: T1/T2 (27.6 kV) - 2032
  - Goreway TS: T5/T6 DESN - 2034
  - Bramalea TS: T3/T4 DESN – 2036<sup>4</sup>
  - Tremaine TS: T1/T2 DESN - 2039

The TWG will be reviewing these needs in the next regional planning cycle.

### 7.8.2 Long-Term Growth & NWGTA Electricity Corridor Need

The 2015 GTA West RIP had indicated the need for a new transmission corridor connecting Milton TS in the west to Kleinburg TS in the east. The corridor was proposed to provide the necessary transmission infrastructure required to support the load growth expected in the in northern part of the GTA West region as a result of the Provincial Government growth plans.

The Ministry of Energy and the Independent Electricity System Operator (IESO) have been working on the proposal to identify and protect a corridor of land for the future transmission corridor [5]

The TWG supports the initiative for the development of the new corridor as it will be essential to meet the future area growth. The progress of corridor development will be reviewed in the next regional planning cycle.

---

<sup>4</sup> This need will be addressed by the planned replacement of Bramalea TS T3 and T4 230/44kV, 50/83MVA transformers in 2028 with larger size 75/125MVA units.

## 8. CONCLUSIONS

THIS REGIONAL INFRASTRUCTURE PLAN REPORT CONCLUDES THE REGIONAL PLANNING PROCESS FOR THE GTA WEST REGION.

The major infrastructure investments recommended by the Technical Working Group (TWG) in the near and medium-term planning horizon (2021-2031) are provided in Table 8-1 below, along with their planned in-service dates and budgetary estimates for planning purposes.

**Table 8-1 Recommended Plans in Toronto Region over the Next 10 Years**

No.	Need	Recommended Action Plan	Lead	Timing	Budgetary Estimates <sup>1</sup>
1	Palermo TS: Transformers T3 and T4 replacement. Also increased capacity required for Milton Hydro	Replace existing transformers with larger 75/125MVA units and modify/upgrade existing LV switchyard	Hydro One	2026	\$30M
2	Relief required for H29/H30 line supplying Pleasant TS	Reconductor line to meet expected load demand	Hydro One	2027	\$8M
3	Section of R19TH/R21H overloaded under certain outage conditions	Review Mitigation <sup>2</sup>	Hydro One	2030	TBD <sup>3</sup>
4	Station loading exceeds LTR <ul style="list-style-type: none"> <li>• Pleasant TS: T1/T2 DESN</li> <li>• Erindale TS: T1/T2 DESN</li> <li>• Cardiff TS: T1/T2 DESN</li> <li>• Erindale: T5/T6 DESN</li> </ul>	Balance load between DESNs	Alectra/ Hydro One	2027 2028 2029 2031	TBD <sup>3</sup>
5	Asset Replacement: <ul style="list-style-type: none"> <li>• Bramalea TS</li> <li>• Tomken TS</li> <li>• Lorne Park TS</li> </ul>	Refurbish/replace major high voltage transmission equipment	Hydro One	2028 2030 2030	\$20M \$49M \$14M
6	T38B/T39 Loading exceed load security criteria	Review Mitigation <sup>2</sup>	Hydro One	2030	TBD <sup>3</sup>

<sup>1</sup> Excludes cost for distribution infrastructure.

<sup>2</sup> The IRRP had proposed alternatives for mitigation. The alternatives and project timing will be reviewed and finalized in the next regional planning cycle.

<sup>3</sup> TBD – To be determined. The costs will depend on the alternative selected and therefore are not available at this time.

The GTA West TWG recommends that:

- Hydro One and LDCs to continue with the implementation of infrastructure investments listed in Table 8-1.
- All the other identified needs/options will be further reviewed by the TWG in the next regional planning cycle.

The next regional planning cycle for the GTA West Region must be triggered within five years, beginning with the Needs Assessment (“NA”) phase. It is expected that the next NA will start in Q1 2024. If a need(s) emerges before this time, the next regional planning cycle can be started earlier to address the need(s).

## 9. REFERENCES

- [1] [GTA West Integrated Regional Resource Plan, July 2021](#)
- [2] [Needs Assessment Report GTA West, May 2019](#)
- [3] [GTA West Regional Infrastructure Plan - January 25, 2016](#)
- [4] [Local Planning Report – Erindale TS T1/T2 DESN Capacity Relief, July, 2015](#)
- [5] [Proposal for NWGTA Transmission Corridor - Revised Study November 18, 2020](#)

## APPENDIX A. GTA WEST REGION - STATIONS

Station (DESN)	Voltage (kV)	Supply Circuits
Bramalea TS T1/T2	230/27.6	V41H/V42H
Bramalea TS T3/T4	230/44	V41H/V42H
Bramalea TS T5/T6	230/27.6	V41H/V42H
Cardiff TS T1/T2	230/27.6	V41H/V42H
Churchill Meadows TS T1/T2	230/44	R19TH / R21TH
Cooksville TS T1/T2	230/27.6	B16C/K21C
Cooksville TS T3/T4	230/27.6	B16C/K21C
Erindale TS T1/T2	230/27.6	R14T / R17T
Erindale TS T3/T4	230/44	R14T / R17T
Erindale TS T5/T6	230/44	R19TH / R21TH
Glenorchy MTS#1	230/27.6	T36B / T37B
Goreway TS (T1/T2, T5/T6)	230/27.6	V42H / V43
Goreway TS T5/T6	230/27.6	V42H / V43
Goreway TS T4	230/44	V43
Jim Yarrow MTS T1/T2	230/27.6	R19TH / R21TH
Halton Hills Hydro MTS	230/27.6	T38B/T39B
Halton TS T3/T4	230/27.6	T38B/T39B
Kleinburg TS T1/T2	230/27.6	V43/V44
Kleinburg TS T1/T2	230/44	V43/V44
Lorne Park TS T1/T2	230/27.6	B15C / B16C
Meadowvale TS T1/T2	230/27.6	T38B / T39B
Oakville TS # 2 T1/T2	230/27.6	B15C / B16C
Oakville TS # 2 T5/T6	230/27.6	B15C / B16C
Palermo TS T3/T4	230/27.6	T36B / T37B
Pleasant TS T1/T2	230/44	H29 / H30
Pleasant TS T5/T6	230/27.6	H29 / H30
Pleasant TS T7/T8	230/27.6	H29 / H30
Tomken TS (T1/T2)	230/44	R14T/R17T
Tomken TS (T3/T4)	230/44	R19TH/R21TH
Trafalgar TS T1/T2	230/27.6	T38B/T39B
Tremaine TS T1/T2	230/27.6	T38B/T39B

## APPENDIX B. GTA WEST REGION - TRANSMISSION LINES

No.	Circuit ID	From Station	To Station	Voltage (kV)
1	H29/H30	Hurontario SS	Pleasant TS	230
2	R14T/R17T	Richview TS	Trafalgar TS	230
3	R19TH/R21TH	Richview TS	Trafalgar TS/ Hurontario SS	230
4	T36B/T37B	Trafalgar TS	Burlington TS	230
5	T38B/ T39B	Trafalgar TS	Burlington TS	230
6	V41H/V42H	Claireville TS	Hurontario SS	230
7	V43/V44	Claireville TS	Kleinburg TS	230
8	B15C/B16C	Cooksville TS	Oakville TS	230
9	K21C/K23C	Manby TS	Cooksville TS	230
10	R24C	Richview TS	Cooksville TS	230

## APPENDIX C. GTA WEST REGION - DISTRIBUTORS

Distributor Name	Station Name	Connection Type
Alectra Utilities Corporation	Bramalea TS	Tx / Dx
	Cardiff TS	Tx
	Churchill Meadows TS	Tx
	Cooksville TS	Tx
	Erindale TS	Tx
	Goreway TS	Tx
	Jim Yarrow MTS	Tx
	Kleinburg TS	Tx
	Lorne Park TS	Tx
	Meadowvale TS	Tx
	Oakville TS#2	Dx
	Pleasant TS	Tx
	Tomken TS	Tx
Distributor Name	Station Name	Connection Type
Burlington Hydro	Palermo TS	Tx
	Tremaine TS	Tx
Distributor Name	Station Name	Connection Type
Halton Hills Hydro Inc.	Halton TS	Tx / Dx
	Halton Hills MTS	Tx
	Pleasant TS	Dx
Distributor Name	Station Name	Connection Type
Hydro One Networks Inc.	Bramalea TS	Tx
	Halton TS	Tx
	Oakville TS #2	Tx
	Palermo TS	Tx
	Pleasant TS	Tx
	Trafalgar TS	Tx
Distributor Name	Station Name	Connection Type
Milton Hydro	Halton TS	Tx
	Palermo TS	Dx
	Tremaine TS	Tx
Distributor Name	Station Name	Connection Type
Oakville Hydro Electricity Distribution Inc.	Glenorchy MTS#1	Tx
	Oakville TS#2	Tx
	Palermo TS	Tx
	Trafalgar TS	Dx



## APPENDIX D. GTA WEST REGION - STATIONS LOAD FORECAST

**GTA West Non-Coincident Station Load Forecast (MW)**

Station	DESN ID	Bus ID	LTR (MW)	2019	2020	2021	2022	2023	2024	2025	2026	2027	2028	2029	2030	2031	2032	2033	2034	2035	2036	2037	2038	2039	2040	2041
Bramalea TS	T1/T2	BY (27.6 kV)	185	103	128	97	96	98	101	101	101	102	103	105	107	108	109	111	112	113	114	114	115	116	116	117
	T3/T4	JQ (44kV)	106	110	95	103	102	101	100	100	100	99	100	101	102	103	104	105	106	106	107	108	108	109	110	110
	T5/T6	EZ (44kV)	159	92	86	98	101	100	99	99	100	100	100	101	102	102	103	104	105	105	106	106	106	107	107	107
<b>Bramalea TS Total</b>			450	305	309	297	299	299	300	299	300	301	303	307	310	313	316	320	322	324	326	328	330	331	333	335
Cardiff TS	T1/T2	BQ (27.6 kV)	114	102	89	103	102	100	99	102	106	110	114	119	120	121	122	124	124	125	125	126	126	127	127	128
Churchill Meadows TS	T1/T2	BY (44kV)	173	107	110	106	105	103	102	101	101	101	101	102	104	105	107	108	109	110	111	112	113	114	115	116
Cooksville TS	T1/T2	EZ (27.6kV)	120	47	44	51	50	49	53	56	58	62	66	67	68	69	70	71	72	72	73	73	74	74	75	76
	T3/T4	JQ (27.6 kV)	120	60	63	59	59	62	66	70	72	72	72	72	73	74	75	76	77	78	78	79	80	80	81	81
<b>Cooksville TS Total</b>			239	107	107	110	109	112	119	126	130	134	138	140	141	143	145	147	149	150	151	152	153	155	156	157
Erindale TS	T5/T6	BJ (44kV)	195	116	154	142	141	139	137	145	153	163	172	182	193	196	198	201	203	205	206	217	227	228	229	230
	T1/T2	EQ (27.6 kV)	181	153	178	142	147	151	156	162	168	175	182	190	192	195	197	200	202	203	205	207	208	209	210	211
	T3/T4	ZY (44kV)	193	129	156	139	141	142	144	143	143	144	144	146	147	150	152	154	155	157	158	159	161	162	163	164
<b>Erindale TS Total</b>			569	398	488	424	429	432	438	449	464	483	498	518	532	540	547	554	560	565	569	582	596	599	602	605
Glenorchy MTS #1	T1/T2	JQ (27.6 kV)	153	55	62	74	95	103	106	113	118	123	127	129	132	134	137	99	102	104	106	105	105	105	105	105
Goreway TS	T1/T2	JQ (27.6 kV)	184	60	73	53	54	58	61	65	69	72	75	78	79	81	82	84	85	86	87	88	88	89	90	91
	T4	M36 (44kV)	78	27	26	22	21	20	19	19	19	19	19	19	20	20	20	21	21	21	21	21	21	21	21	22
	T5/T6	BY (27.6 kV)	173	160	173	153	152	152	152	153	155	157	159	162	165	168	170	173	174	175	176	177	178	178	179	180
<b>Goreway TS Total</b>			435	247	272	228	228	230	233	237	243	248	253	259	264	269	273	277	279	282	284	285	287	288	290	292
Halton Hills MTS	T1/T2	(27.6)	83	8	3	18	18	18	30	33	38	30	35	43	54	66	79	45	52	52	52	53	53	53	53	54
Halton TS	T3/T4	JQ (27.6 kV)	186	160	151	153	144	150	155	158	161	161	160	163	163	163	163	164	164	163	163	164	164	163	163	163
Halton TS#2	T1/T2	(blank)	180	0	0	0	0	0	0	0	0	0	0	0	0	0	0	89	97	107	116	125	136	148	160	174
Jim Yarrow MTS	T1/T2	AB (28kV)	157	124	138	135	135	133	134	137	140	143	146	149	153	156	159	162	163	164	166	166	167	168	168	169
Kleinburg TS	T1/T2	JQ (44kV)	99	84	89	83	83	83	82	83	83	83	84	84	83	83	84	84	84	83	85	85	85	85	85	85
	T1/T2	BY (27.6 kV)	97	60	65	59	58	59	68	80	80	80	80	80	80	79	99	99	99	100	100	100	100	100	100	100
<b>Kleinburg TS Total</b>			196	144	154	142	141	142	151	163	163	163	164	164	163	163	183	182	182	183	184	184	184	184	184	184

Station	DESN ID	Bus ID	LTR (MW)	2019	2020	2021	2022	2023	2024	2025	2026	2027	2028	2029	2030	2031	2032	2033	2034	2035	2036	2037	2038	2039	2040	2041
Lorne Park TS	T1/T2	BJ (27.6 kV)	137	78	109	83	87	89	89	88	88	88	88	89	90	91	93	94	95	96	96	97	98	99	99	100
Meadowvale TS	T1/T2	EZ (44kV)	181	112	152	119	118	121	124	128	132	136	136	137	138	140	142	144	145	146	148	149	150	151	152	154
Oakville TS #2	T1/T2	EZ (27.6 kV)	175	139	145	160	159	157	155	155	154	154	154	155	156	156	157	158	158	158	159	159	159	160	160	160
Palermo TS	T3/T4	BY (27.6 kV)	180	113	129	125	115	113	113	112	112	129	133	134	135	137	139	141	142	144	146	147	149	151	153	155
Pleasant TS	T1/T2	JQ (44K)	148	113	128	138	142	147	147	147	148	149	150	151	152	154	155	156	157	159	160	160	161	161	162	163
	T5/T6	BY, EZ (27.6 kV)	181	165	182	154	154	154	154	155	156	156	157	158	160	161	162	163	164	165	166	167	168	168	169	170
	T7/T8	FV (27.6 kV)	188	89	128	90	90	90	95	102	110	117	124	130	137	144	150	157	159	161	163	164	165	166	166	168
<b>Pleasant TS Total</b>			517	367	438	383	387	391	396	404	413	422	431	440	449	459	468	477	481	485	489	491	493	495	497	500
Tomken TS	T1/T2	BY (44kV)	164	162	111	129	128	126	124	123	123	123	123	125	126	135	144	153	154	155	157	158	159	160	162	163
	T3/T4	EZ (44kV)	183	105	130	127	126	124	122	121	121	121	121	123	124	126	128	129	137	146	154	155	156	157	159	160
<b>Tomken TS Total</b>			347	267	241	257	253	249	247	245	245	244	245	247	251	261	271	282	292	301	310	313	315	318	320	323
Trafalgar TS	T1/T2	BY (27.6 kV)	124	68	76	107	106	105	104	103	103	103	103	103	103	103	103	104	104	103	103	103	103	103	103	103
Tremaine TS	T1/T2	BY (27.6 kV)	189	71	112	126	130	136	142	144	146	148	150	152	155	159	163	168	173	178	183	183	189	192	196	196
Customer #1 CTS	T1/T2	BY (27.6 kV)	83	30	30	30	30	30	30	30	30	30	30	30	30	30	30	30	30	30	30	30	30	30	30	30
<b>Total</b>			4868	3002	3314	3184	3188	3213	3266	3327	3388	3450	3510	3578	3643	3710	3796	3866	3923	3972	4018	4056	4101	4137	4174	4212

**Notes:**

- Load forecast is based on the IESO July 2021 IRRP forecast and adjusted for input provided by Alectra, Milton Hydro and Hydro One Distribution..
- Halton TS# 2 is assumed to be in service in 2033

## APPENDIX E. LIST OF ACRONYMS

Acronym	Description
A	Ampere
BES	Bulk Electric System
BPS	Bulk Power System
CDM	Conservation and Demand Management
CIA	Customer Impact Assessment
GS	Generating Station
CTS	Customer Transformer Station
DESN	Dual Element Spot Network
DER	Distributed Energy Resource
DG	Distributed Generation
DSC	Distribution System Code
GS	Generating Station
GTA	Greater Toronto Area
HV	High Voltage
IESO	Independent Electricity System Operator
IRRP	Integrated Regional Resource Plan
kV	Kilovolt
LDC	Local Distribution Company
LP	Local Plan
LTE	Long Term Emergency
LTR	Limited Time Rating
LV	Low Voltage
MTS	Municipal Transformer Station
MW	Megawatt
MVA	Mega Volt-Ampere
MVAR	Mega Volt-Ampere Reactive
NA	Needs Assessment
NERC	North American Electric Reliability Corporation
NGS	Nuclear Generating Station
NPCC	Northeast Power Coordinating Council Inc.
NUG	Non-Utility Generator
OEB	Ontario Energy Board
OPA	Ontario Power Authority
ORTAC	Ontario Resource and Transmission Assessment Criteria
PF	Power Factor
PPWG	Planning Process Working Group
RIP	Regional Infrastructure Plan
ROW	Right-of-Way
SA	Scoping Assessment
SIA	System Impact Assessment
SPS	Special Protection Scheme
SS	Switching Station
TS	Transformer Station
TSC	Transmission System Code
UFLS	Under Frequency Load Shedding
ULTC	Under Load Tap Changer
UVLS	Under Voltage Load Rejection Scheme